



Agilent X-Series Wireless Communications Test Set

This manual provides documentation
for the following test sets:

EXT Test Set E6607A/B/C

Instrument Messages

Notices

© Agilent Technologies, Inc.
2011-2013

No part of this manual may be reproduced in any form or by any means (including electronic storage and retrieval or translation into a foreign language) without prior agreement and written consent from Agilent Technologies, Inc. as governed by United States and international copyright laws.

Trademark Acknowledgements

Microsoft® is a U.S. registered trademark of Microsoft Corporation.

Windows® and MS Windows® are U.S. registered trademarks of Microsoft Corporation.

Adobe Acrobat® and Reader® are U.S. registered trademarks of Adobe Systems Incorporated.

Java™ is a U.S. trademark of Sun Microsystems, Inc.

MATLAB® is a U.S. registered trademark of Math Works, Inc.

Norton Ghost™ is a U.S. trademark of Symantec Corporation.

Wikipedia® is a registered trademark of the Wikimedia Foundation.

Manual Part Number

E6607-90042

Supersedes: E6607-90008 and E6607-90021

Print Date

February 2013

Supersedes: N/A

Printed in USA

Agilent Technologies Inc.
1400 Fountaingrove Parkway
Santa Rosa, CA 95403

Warranty

The material contained in this document is provided “as is,” and is subject to being changed, without notice, in future editions. Further, to the maximum extent permitted by applicable law, Agilent disclaims all warranties, either express or implied, with regard to this manual and any information contained herein, including but not limited to the implied warranties of merchantability and fitness for a particular purpose. Agilent shall not be liable for errors or for incidental or consequential damages in connection with the furnishing, use, or performance of this document or of any information contained herein. Should Agilent and the user have a separate written agreement with warranty terms covering the material in this document that conflict with these terms, the warranty terms in the separate agreement shall control.

Technology Licenses

The hardware and/or software described in this document are furnished under a license and may be used or copied only in accordance with the terms of such license.

Restricted Rights Legend

If software is for use in the performance of a U.S. Government

prime contract or subcontract, Software is delivered and licensed as “Commercial computer software” as defined in DFAR 252.227-7014 (June 1995), or as a “commercial item” as defined in FAR 2.101(a) or as “Restricted computer software” as defined in FAR 52.227-19 (June 1987) or any equivalent agency regulation or contract clause. Use, duplication or disclosure of Software is subject to Agilent Technologies’ standard commercial license terms, and non-DOD Departments and Agencies of the U.S. Government will receive no greater than Restricted Rights as defined in FAR 52.227-19(c)(1-2) (June 1987). U.S. Government users will receive no greater than Limited Rights as defined in FAR 52.227-14 (June 1987) or DFAR 252.227-7015 (b)(2) (November 1995), as applicable in any technical data.

Safety Notices

CAUTION

A **CAUTION** notice denotes a hazard. It calls attention to an operating procedure, practice, or the like that, if not correctly performed or adhered to, could result in damage to the product or loss of important data. Do not proceed beyond a CAUTION notice until the indicated conditions are fully understood and met.

WARNING

A **WARNING** notice denotes a hazard. It calls attention to an operating procedure, practice, or the like that, if not correctly performed or adhered to, could result in personal injury or death. Do not proceed beyond a WARNING notice until the indicated conditions are fully understood and met.

Warranty

This Agilent technologies instrument product is warranted against defects in material and workmanship for a period of one year from the date of shipment. During the warranty period, Agilent Technologies will, at its option, either repair or replace products that prove to be defective.

For warranty service or repair, this product must be returned to a service facility designated by Agilent Technologies. Buyer shall prepay shipping charges to Agilent Technologies, and Agilent Technologies shall pay shipping charges to return the product to Buyer. For products returned to Agilent Technologies from another country, Buyer shall pay all shipping charges, duties, and taxes.

Where to Find the Latest Information

Documentation is updated periodically. For the latest information about these products, including instrument software upgrades, application information, and product information, browse to one of the following URLs, according to the name of your product:

<http://www.agilent.com/find/ext>

To receive the latest updates by email, subscribe to Agilent Email Updates at the following URL:

<http://www.agilent.com/find/emailupdates>

Information on preventing test set damage can be found at:

<http://www.agilent.com/find/tips>

Is your product software up-to-date?

Periodically, Agilent releases software updates to fix known defects and incorporate product enhancements. To search for software updates for your product, go to the Agilent Technical Support website at:

<http://www.agilent.com/find/techsupport>

Contacting Agilent Technologies

For assistance, contact your nearest Agilent Technologies Sales and Service Office. To find your local Agilent office access the following URL, or if in the United States, call the following telephone number:

<http://www.agilent.com/find/assist>

1-800-829-4444 (8 am - 8 pm ET, Monday - Friday)

1. Introduction

Event and Condition Categories	36
Event Message Format	38
Event Queues	39

2. Instrument Messages

Advisory Messages	42
Event Messages.	48
–800, Operation Complete Event	48
–700, Request Control Event	48
–600, User Request Event	48
–500, Power on Event	49
–400 to –499, Query Errors.	49
–300 to –399, Device-Specific Errors.	50
–221 Settings Conflict Errors	53
–200 to –299, Execution Errors.	69
–100 to –199, Command Errors	84
0 Error	86
Condition Messages	87
Condition errors 1 to 99, Calibration	87
Condition Errors 6 to 34, Calibration Skipped	87
Condition Errors 36 to 64, Calibration Needed or Failed	88
Condition Errors 65 to 92, Calibration Needed (Extended)	89
Condition Errors 67 to 95, Calibration Failure (Extended).	90
Condition Errors 101 to 199, Measurement Integrity	91
Condition Errors 201 to 299, Signal Integrity.	95
Condition Errors 301 to 399, Uncalibrated Integrity	100
Condition Errors 401 to 499, Power	104
Condition Errors 501 to 599, Frequency.	105
Condition Errors 601 to 699, Error Summaries	106
Condition Errors 701 to 799, Operation	107
Condition Errors 801 to 899, Temperature	108

3. STATus Subsystem

Detailed Description	113
What Are Status Registers.	113
What Are Status Register SCPI Commands	114
How to Use the Status Registers	114
Using a Status Register	115
Using the Service Request (SRQ) Method	116
Generating a Service Request	117
Status Register System	118
The Status Byte Register.	118
Standard Event Status Register	121
Operation and Questionable Status Registers	123
Operation Status Register	123
Questionable Status Register.	124
STATus Subsystem Command Descriptions.	125

Operation Register	125
Operation Condition Query	125
Operation Enable	125
Operation Event Query	126
Operation Negative Transition	127
Operation Positive Transition	127
Preset the Status Byte	128
Questionable Register	128
Questionable Condition	128
Questionable Enable	128
Questionable Event Query	129
Questionable Negative Transition	129
Questionable Positive Transition	130
Questionable Calibration Register	131
Questionable Calibration Condition	131
Questionable Calibration Enable	131
Questionable Calibration Event Query	131
Questionable Calibration Negative Transition	132
Questionable Calibration Positive Transition	132
Questionable Calibration Skipped Register	133
Questionable Calibration Skipped Condition	133
Questionable Calibration Skipped Enable	133
Questionable Calibration Skipped Event Query	134
Questionable Calibration Skipped Negative Transition	134
Questionable Calibration Skipped Positive Transition	135
Questionable Calibration Extended Failure Register	135
Questionable Calibration Extended Failure Condition	135
Questionable Calibration Extended Failure Enable	136
Questionable Calibration Extended Failure Event Query	136
Questionable Calibration Extended Failure Negative Transition	137
Questionable Calibration Extended Failure Positive Transition	137
Questionable Calibration Extended Needed Register	138
Questionable Calibration Extended Needed Condition	138
Questionable Calibration Extended Needed Enable	138
Questionable Calibration Extended Needed Event Query	139
Questionable Calibration Extended Needed Negative Transition	139
Questionable Calibration Extended Needed Positive Transition	140
Questionable Frequency Register	140
Questionable Frequency Condition	140
Questionable Frequency Enable	141
Questionable Frequency Event Query	141
Questionable Frequency Negative Transition	142
Questionable Frequency Positive Transition	142
Questionable Integrity Register	143
Questionable Integrity Condition	143
Questionable Integrity Enable	143
Questionable Integrity Event Query	143
Questionable Integrity Negative Transition	144
Questionable Integrity Positive Transition	144

Questionable Integrity Signal Register	145
Questionable Integrity Signal Condition	145
Questionable Integrity Signal Enable	145
Questionable Integrity Signal Event Query	146
Questionable Integrity Signal Negative Transition	146
Questionable Integrity Signal Positive Transition	147
Questionable Integrity Uncalibrated Register	147
Questionable Integrity Uncalibrated Condition	147
Questionable Integrity Uncalibrated Enable	148
Questionable Integrity Uncalibrated Event Query	148
Questionable Integrity Uncalibrated Negative Transition	149
Questionable Integrity Uncalibrated Positive Transition	149
Questionable Power Register	150
Questionable Power Condition	150
Questionable Power Enable	150
Questionable Power Event Query	151
Questionable Power Negative Transition	151
Questionable Power Positive Transition	151
Questionable Temperature Register	152
Questionable Temperature Condition	152
Questionable Temperature Enable	152
Questionable Temperature Event Query	153
Questionable Temperature Negative Transition	153
Questionable Temperature Positive Transition	154

:STATus:OPERation:CONDition?	125
:STATus:OPERation:ENABle <integer>	126
:STATus:OPERation:ENABle?	126
:STATus:OPERation:NTRansition <integer>	127
:STATus:OPERation:NTRansition?	127
:STATus:OPERation:PTRansition <integer>	127
:STATus:OPERation:PTRansition?	127
:STATus:OPERation[:EVENT]?	126
:STATus:PRESet	128
:STATus:QUEStionable:CALibration:CONDition?	131
:STATus:QUEStionable:CALibration:ENABle <integer>	131
:STATus:QUEStionable:CALibration:ENABle?	131
:STATus:QUEStionable:CALibration:EXTended:FAILure:CONDition?	135
:STATus:QUEStionable:CALibration:EXTended:FAILure:ENABle <integer>	136
:STATus:QUEStionable:CALibration:EXTended:FAILure:ENABle?	136
:STATus:QUEStionable:CALibration:EXTended:FAILure:NTRansition <integer>	137
:STATus:QUEStionable:CALibration:EXTended:FAILure:NTRansition?	137
:STATus:QUEStionable:CALibration:EXTended:FAILure:PTRansition <integer>	137
:STATus:QUEStionable:CALibration:EXTended:FAILure:PTRansition?	137
:STATus:QUEStionable:CALibration:EXTended:FAILure[:EVENT]?	136
:STATus:QUEStionable:CALibration:EXTended:NEEDed:CONDition?	138
:STATus:QUEStionable:CALibration:EXTended:NEEDed:ENABle <integer>	138
:STATus:QUEStionable:CALibration:EXTended:NEEDed:ENABle?	138
:STATus:QUEStionable:CALibration:EXTended:NEEDed:NTRansition <integer>	139
:STATus:QUEStionable:CALibration:EXTended:NEEDed:NTRansition?	139
:STATus:QUEStionable:CALibration:EXTended:NEEDed:PTRansition <integer>	140
:STATus:QUEStionable:CALibration:EXTended:NEEDed:PTRansition?	140
:STATus:QUEStionable:CALibration:EXTended:NEEDed[:EVENT]?	139
:STATus:QUEStionable:CALibration:NTRansition <integer>	132
:STATus:QUEStionable:CALibration:NTRansition?	132
:STATus:QUEStionable:CALibration:PTRansition <integer>	133

Remote commands and Instrument Messages

Alphabetical Listing

:STATUS:QUESTIONable:CALibration:PTRansition?	133
:STATUS:QUESTIONable:CALibration:SKIPped:CONDition?	133
:STATUS:QUESTIONable:CALibration:SKIPped:ENABle <integer>.	133
:STATUS:QUESTIONable:CALibration:SKIPped:ENABle?	133
:STATUS:QUESTIONable:CALibration:SKIPped:NTRansition <integer>	134
:STATUS:QUESTIONable:CALibration:SKIPped:NTRansition?	134
:STATUS:QUESTIONable:CALibration:SKIPped:PTRansition <integer>.	135
:STATUS:QUESTIONable:CALibration:SKIPped:PTRansition?	135
:STATUS:QUESTIONable:CALibration:SKIPped[:EVENT]?	134
:STATUS:QUESTIONable:CALibration[:EVENT]?	132
:STATUS:QUESTIONable:CONDition?	128
:STATUS:QUESTIONable:ENABle 16 Sets the register so that temperature summary will be reported to the Status Byte Register	129
:STATUS:QUESTIONable:ENABle?	129
:STATUS:QUESTIONable:FREQuency:CONDition?	140
:STATUS:QUESTIONable:FREQuency:ENABle <integer>.	141
:STATUS:QUESTIONable:FREQuency:ENABle?	141
:STATUS:QUESTIONable:FREQuency:NTRansition <integer>	142
:STATUS:QUESTIONable:FREQuency:NTRansition?	142
:STATUS:QUESTIONable:FREQuency:PTRansition <integer>.	142
:STATUS:QUESTIONable:FREQuency:PTRansition?	142
:STATUS:QUESTIONable:FREQuency[:EVENT]?	141
:STATUS:QUESTIONable:INTegrity:CONDition?	143
:STATUS:QUESTIONable:INTegrity:ENABle <integer>.	143
:STATUS:QUESTIONable:INTegrity:ENABle?	143
:STATUS:QUESTIONable:INTegrity:NTRansition <integer>	144
:STATUS:QUESTIONable:INTegrity:NTRansition?	144
:STATUS:QUESTIONable:INTegrity:PTRansition <integer>	145
:STATUS:QUESTIONable:INTegrity:PTRansition?	145
:STATUS:QUESTIONable:INTegrity:SIGNal:CONDition?	145
:STATUS:QUESTIONable:INTegrity:SIGNal:ENABle <integer>	145

:STATus:QUEStionable:INTegrity:SIGNal:ENABle?	145
:STATus:QUEStionable:INTegrity:SIGNal:NTRansition <integer>	146
:STATus:QUEStionable:INTegrity:SIGNal:NTRansition?	146
:STATus:QUEStionable:INTegrity:SIGNal:PTRansition <integer>	147
:STATus:QUEStionable:INTegrity:SIGNal:PTRansition?	147
:STATus:QUEStionable:INTegrity:SIGNal[:EVENT]?	146
:STATus:QUEStionable:INTegrity:UNCalibrated:CONDition?	147
:STATus:QUEStionable:INTegrity:UNCalibrated:ENABle?	148
:STATus:QUEStionable:INTegrity:UNCalibrated:ENABle	148
:STATus:QUEStionable:INTegrity:UNCalibrated:NTRansition <integer>	149
:STATus:QUEStionable:INTegrity:UNCalibrated:NTRansition?	149
:STATus:QUEStionable:INTegrity:UNCalibrated:PTRansition <integer>	149
:STATus:QUEStionable:INTegrity:UNCalibrated:PTRansition?	149
:STATus:QUEStionable:INTegrity:UNCalibrated[:EVENT]?	148
:STATus:QUEStionable:INTegrity[:EVENT]?	144
:STATus:QUEStionable:NTRansition 16 Temperature summary ‘questionable cleared’ will be reported to the Status Byte Register.	130
:STATus:QUEStionable:NTRansition?	130
:STATus:QUEStionable:POWer:CONDition?	150
:STATus:QUEStionable:POWer:ENABle <integer>	150
:STATus:QUEStionable:POWer:ENABle?	150
:STATus:QUEStionable:POWer:NTRansition <integer>	151
:STATus:QUEStionable:POWer:NTRansition?	151
:STATus:QUEStionable:POWer:PTRansition <integer>	152
:STATus:QUEStionable:POWer:PTRansition?>	152
:STATus:QUEStionable:POWer[:EVENT]?	151
:STATus:QUEStionable:PTRansition <integer>	130
:STATus:QUEStionable:PTRansition?	130
:STATus:QUEStionable:TEMPerature:CONDition?	152
:STATus:QUEStionable:TEMPerature:ENABle <integer>	153
:STATus:QUEStionable:TEMPerature:ENABle?	153

Remote commands and Instrument Messages

Alphabetical Listing

:STATus:QUESTionable:TEMPerature:NTRansition <integer>	154
:STATus:QUESTionable:TEMPerature:NTRansition?	154
:STATus:QUESTionable:TEMPerature:PTRansition <integer>	154
:STATus:QUESTionable:TEMPerature:PTRansition?	154
:STATus:QUESTionable:TEMPerature[:EVENT]?	153
:STATus:QUESTionable[:EVENT]?	129
2nd LO Unlocked.	105
AC coupled: Accy unspec'd <10 MHz	101
ADC Alignment Failure.	89
Align 30MHz to 1GHz failed.	91
Align 30MHz–1GHz required	90
Align 9kHz to 30MHz failed	91
Align 9kHz–30MHz required	90
Align Now, All required.	89
Align Now, RF required.	89
Align RF Skipped.	87
Align Skipped Sum Summary	89
Align Source IQ failed.	91
Align Source RF failed	91
All Auto/Man functions have been set to Auto	42
All Auto/Man functions have been set to Auto.	42
All ranges are off. Turn on at least a range	69
Allowable Center Frequency exceeded for the current span	42
Allowable Span exceeded for the current center frequency	42
Allowable Start Frequency exceeded for the current span.	42
Allowable Stop frequency exceeded for the current span	42
Already in Single, press Restart to initiate a new sweep or sequence	42
Arm deadlock.	72
Arm ignored	71
At Full Zoom	69
At Full Zoom	69

Auto sweep time rules do not apply in FFT sweeps.	42
Band Adjust has no effect on a Fixed marker	42
Band Adjust has no effect with Mkr Function Off.	43
Band-pass filter set to OFF.	43
Block data error	85
Block data not allowed.	85
Burst Not Found	97
Burst not found;with selected Time Slot	97
Cal Cancelled; Calibration data cleared	43
Cal Invalid: meas freq pt(s) > 3.6GHz are > 50MHz from existing Cal pts	43
Calibrating	107
Calibration failed	52
Calibration failed; no signal detected; <port>	52
Calibration memory lost.	51
Calibration Oscillator Unlocked.	105
Calibration	103
Calibration	107
Calibration; ENR table extrapolated	103
Calibration; No ENR data present	103
Cannot create program	82
Carrier power is too low for optimum dynamic range.	43
Carrier(s) incorrect or missing	98
Character data error	85
Character data not allowed	85
Character data too long.	85
Characterize Preselector failure	91
Command error.	84
Command header error.	84
Command protected	71
Command protected; feature not licensed	71
Command protected; Feature Not Supported. No appropriate waveform license installed for <filename>	71

Remote commands and Instrument Messages

Alphabetical Listing

Communication error	52
Communication error; SNS data read failure. Disconnect then reconnect SNS	52
Communication error; SNS is not connected.	53
Configuration memory lost	51
Connecting to source.	43
Corrupt media	80
Data corrupt or stale; Measurement data is not available	76
Data corrupt or stale; Trace contains no data.	76
Data corrupt or stale; Unable to load state from file	77
Data corrupt or stale;	76
Data out of Range; clipped to source max/min	74
Data out of range; Invalid list data.	74
Data out of range; Two entries already exist at this x-axis value.	74
Data out of range;.	74
Data questionable.	77
Data type error	84
DC Coupled	108
De-emphasis only available in FM	54
Demod Error	99
Demod Error;Acq Time too short	100
Demod Error;Can't correlate	99
Demod Error;Data interval too short	99
Demod Error;Muxed bits not found.	100
Demod Error;No active channel	99
Demod Error;No full subframe found	100
Demod Error;Not an active slot.	99
Demod Time is not available in Zero Span	43
Demodulation.	105
Detector <X> changed due to physical constraints	43
Device-specific error	50
Directory full	81

Dynamic range is not optimum. Set AUTO RF input.....	43
Execution Error	69
Execution error; Carrier frequency outside device's transmit band.....	69
Execution error; Invalid GSM burst timing	69
Execution error; Invalid IP address	70
Execution error; Invalid Marker Trace.	70
Execution Error; No peak found.	70
Execution error; No ranges are defined. Activate a range.....	70
Execution Error; Preselector centering failed.	70
Execution Error; Signal not stable enough to track	70
Execution Error; Store ref trace before turning on Normalize.....	70
Execution error; Sync word was not found.....	70
Execution error; Trace file contains no compatible traces.	70
Execution error; Trace file created by incompatible version of Phase Noise App.....	70
Exp. Averaging not available when AUTO PhNoise is active.	43
Exponent too large	85
Expression data not allowed.....	86
Expression error	81
Expression error	85
Extended Align Failure Summary	89
Extended Align Needed Summary	89
FFT Width is not settable unless Sweep Type is set to FFT.....	43
File <filename> saved	43
File name error; <filename> contains unrecognized file suffix	81
File name error; Allowable extension is .csv	81
File name error; Allowable extension is .png.....	81
File name error; Allowable extension is .state	81
File name error; Invalid file name	81
File name error; name too long	81
File name error; Waveform file not selected	81
File name error;	81

Remote commands and Instrument Messages

Alphabetical Listing

File name not found:<file name>.....	81
File name not found;	81
Filter BW function is only available for Gaussian filter type	43
Fixed LO freq should be greater than RF Stop freq	44
FM Demod Alignment Failure.....	89
Framing error in program message	53
Freq Out of Range	98
Freq Out of Range; External LO	98
Freq Out of Range; System input (IF)	98
Freq Scale Type=Log is not available in Zero Span	44
Frequency Hopping enabled, waiting for valid burst.....	44
Frequency menu has changed to reflect frequency context switch	44
Frequency Reference Unlocked.....	105
Frequency.....	106
Function not available before Marker Zoom is performed	70
Function not available in Zero Span	54
Gate required for valid results	44
GET not allowed	84
Hardware error.....	77
Hardware error; See details in Windows Event Log under SA	77
Hardware missing	77
Hardware missing; Input not available	77
Hardware missing; Internal preamp not available at all frequency points.....	78
Hardware missing; not available for this model number.....	78
Hardware missing; Option not installed.....	78
Header separator error	84
Header suffix out of range	84
High-pass and Low-pass filters set to OFF	44
High-pass filter set to OFF.....	44
I/O Error.....	93
I/O Error; Ext Source needs IP Addr.....	93

IF Alignment Failure	89
IF Fixed freq should be greater than LO Stop freq.....	44
IF Fixed freq should be greater than RF Stop freq.....	44
IF Start freq should be greater than LO Fixed freq	44
IF Start freq should be greater than RF Start freq	44
IF Synthesizer Unlocked	105
Illegal macro label	82
Illegal parameter value.....	74
Illegal parameter value; <Value> invalid. Fractional values are not allowed.....	74
Illegal parameter value; <value> out of range.....	74
Illegal parameter value; Cannot set waveform to continue previous waveform on the first step	75
Illegal parameter value; Cannot set waveform to continue previous waveform when previous step is set to CW or Off.....	75
Illegal parameter value; Channel number is invalid for current band/link combination	75
Illegal parameter value; Exceeding the max list length	75
Illegal parameter value; Gated FFT is not available while Sweep Type is set to Swept	75
Illegal parameter value; Gated LO is not available while Sweep Type is set to FFT	75
Illegal parameter value; Gated Video is not available while Sweep Type is set to FFT	75
Illegal parameter value; Illegal identifier <identifier>. This value may already be in use.....	75
Illegal parameter value; Index out of range	75
Illegal parameter value; Invalid list length.....	75
Illegal parameter value; LXI Event <event> already exists.....	75
Illegal parameter value; LXI Event <event> contains illegal characters.....	76
Illegal parameter value; LXI Event <event> does not exist.....	76
Illegal parameter value; Measurement not available	76
Illegal parameter value; This instrument is always DC coupled	76
Illegal parameter value; This model is always AC coupled.....	76
Illegal program name	82
Illegal variable name	82
Incompatible type	83
Init ignored.....	71

Remote commands and Instrument Messages

Alphabetical Listing

Input Attenuation not calibrated	90
Input buffer overrun	53
Input is internal	45
Input Overload	92
Input Overload;ADC over range	92
Input Overload;I/Q ADC over range	92
Input Overload;I/Q Voltage over range	93
Input Overload;RF Preselector Overload.	93
Insufficient Data.	93
Insufficient Data; ENR table empty	93
Insufficient Data; frequency list empty	93
Insufficient Data; Incr. Demod Time	93
Insufficient Data; Loss table empty	93
Integrity	107
Invalid block data.	85
Invalid character data	85
Invalid character in number	84
Invalid character.	84
Invalid Data	94
Invalid expression	85
Invalid format.	77
Invalid format; Map information not loaded	77
Invalid format;<filename> contains invalid waveform header and cannot be loaded into ARB memory	77
Invalid format;<filename> has less than 500 IQ samples	77
Invalid format;Syntax error on source step <step number>.	77
Invalid format;Unable to open encrypted waveform file <filename>.	77
Invalid inside macro definition	86
Invalid outside macro definition	86
Invalid separator.	84
Invalid string data.	85
Invalid suffix	85

Invalid version	77
Invalid while in local	71
List not same length	76
LO Alignment Failure	89
LO Fixed freq should be greater than IF Stop freq.	45
LO Fixed freq should be greater than RF Stop freq.	45
LO Start freq should be greater than IF Fixed freq	45
LO Start freq should be greater than RF Start freq.	45
LO Stop freq should be greater than RF Stop freq.	45
LO Unleveled	104
LO Unlocked	105
Low-pass filter set to OFF	45
Macro definition too long	82
Macro error.	81
Macro error.	86
Macro execution error	82
Macro header not found	82
Macro parameter error	82
Macro parameter error	86
Macro recursion error.	82
Macro redefinition\ not allowed	82
Macro syntax error	82
Mass storage error; Access denied	78
Mass storage error; Bad path name	78
Mass storage error; Can only import single trace .csv files	78
Mass storage error; Can only load an Antenna Unit into Correction 1	78
Mass storage error; Cannot make	78
Mass storage error; Different Antenna Unit already in use	78
Mass storage error; Directory not found	78
Mass storage error; Failed to Load trace. Bad file format.	78
Mass storage error; File <filename> wrong type	78

Remote commands and Instrument Messages

Alphabetical Listing

Mass storage error; File <filename> and instrument version mismatch	79
Mass storage error; File contains incorrect data for this operation	79
Mass storage error; File empty.	79
Mass storage error; Invalid register number for *SAV or *RCL Mass Storage error	79
Mass storage error; Lock violation	79
Mass storage error; Mkr Table must be on to save Mkr Table as Meas Results	79
Mass storage error; No file names available	79
Mass storage error; Open failed.	79
Mass storage error; Pk Table must be on to save Pk Table as Meas Results	79
Mass storage error; Read fault	79
Mass storage error; Register <number> empty.	79
Mass storage error; Sharing violation	79
Mass storage error; Spectrogram must be on to save as Meas Results	79
Mass storage error; Too many open files.	79
Mass storage error; Write fault.	80
Mass storage error;.	78
Mass storage error;<directory> does not exist.	80
Mass storage error;<filename> cannot be deleted as it is currently in use	80
Mass storage error;<filename> cannot be deleted as it is used in sequencer.	80
Mass storage error;<filename> used by sequencer is not in the ARB memory, cannot start sequencer	80
Mass storage error;Create Directory Error: <directory> <err info>	80
Mass storage error;Delete File Error: <filename> <err info>	80
Mass storage error;Write File Error: <filename> <err info>	80
Math error in expression	81
Meas Error	93
Meas Uncal	101
Measuring.	108
Media full.	80
Media Full;<filename> cannot be loaded to ARB memory.	80
Media protected	81
Memory error.	51

Memory Error.....	93
Memory Error;Shorten capture interval.....	93
Memory use errors.....	82
Missing media.....	80
Missing parameter.....	84
MPA Align failed.....	91
MPA Align required.....	90
Must perform Scan before do Search.....	71
No error.....	86
No Long Code Phase.....	101
No marked signal.....	71
No Measure At Marker Added to Signal List.....	71
No Peak Added to Signal List.....	71
No Result.....	92
No Result; Meas invalid with I/Q inputs.....	92
No Result;Turn on MCE.....	92
No spurs have been found.....	45
Numeric data error.....	84
Numeric data not allowed.....	85
Operation complete.....	48
Operation complete; Loaded <ARB filename> successfully, but no license <required licenses> installed.....	48
Out of memory.....	52
Out of memory.....	76
Out of memory.....	82
Out of memory; Insufficient resources to load Mode <mode name>.....	76
Out of memory; Memory limit caused Data Acquisition to be truncated.....	76
Out of memory; Results truncated.....	52
Out of memory; Sequence too long.....	52
Out of memory; Total analysis step reaches its limitation.....	52
Parameter error.....	72
Parameter error; <filename> is not loaded into ARB memory. Load the file before assigning to a multi-pack.....	72

Remote commands and Instrument Messages

Alphabetical Listing

Parameter error;<filename> does not have a unique id, therefore cannot be assigned to a multi-pack	72
Parameter error;Cannot create directory to save waveform sequence file. <error info>.	72
Parameter error;Cannot find the first waveform file <filename>	72
Parameter error;Invalid waveform sequence file path.	72
Parameter error;License slot <n> is already locked.	72
Parameter error;License slot <n> is illegal, slot number must be positive	72
Parameter error;License slot <n> is locked and cannot be cleared	72
Parameter error;License slot <n> is locked, therefore cannot be replaced	73
Parameter error;License slot <n> is not assigned, therefore cannot be locked	73
Parameter error;Nested sequence file is not supported	73
Parameter error;Nested sequence file is not supported	73
Parameter error;No. <n> waveform file path is invalid.	73
Parameter error;Repetition value must be within 1 and 65535	73
Parameter error;Sequence will be stuck on step <step number>. Next step trigger cannot be free run when current step duration is continuous.	73
Parameter error;Suffix of waveform sequence file should be “.seq”.	73
Parameter error;Transition time is longer than duration time on step<step number>	73
Parameter error;Unrecognized marker type: <marker>.	73
Parameter error;Waveform <filename> is already assigned to a waveform slot.	74
Parameter error;Waveform cannot be multi-pack licensed, no multi-pack slots available	74
Parameter error;Waveform of that ID is already multi-pack licensed	74
Parameter not allowed	84
Parity error in program message	53
Paused	108
Power on	49
Power	106
Preparing Calculation.	45
Preselector is centered	45
Preselector not used in this frequency range.	46
Probe connected, cal data is being reapplied; <port>; <probe>.	46
Probe connected, no probe cal; using cable cal data; <port>; <probe>.	46

Probe disconnected, reverting to cable calibration data; <port>	46
Program currently running	82
Program error	82
Program mnemonic too long	84
Program runtime error	82
Program syntax error	82
PUD memory lost	51
Query DEADLOCKED	49
Query Error.	49
Query INTERRUPTED	49
Query UNTERMINATED after indefinite response	49
Query UNTERMINATED	49
Queue overflow	52
Reading SNS data.	46
Recalled File <filename>	46
Ref missing or out of range	105
Ref missing or out of range;External	105
Ref missing or out of range;Pulse	105
Refer to online help for assistance with DSB measurements.	46
Reference name does not exist; Waveform sequence contains an invalid waveform <filename>.	83
Reference Oscillator Oven Cold.	108
Referenced name already exists	83
Referenced name does not exist	83
Request control.	48
Requested timeslot number is not present.	46
RF Alignment Failure.	89
RF Start freq should be greater than IF Fixed freq.	46
RF Start freq should be greater than IF start freq	46
RF Start freq should be greater than LO fixed freq	46
RF Start freq should be greater than LO Start freq.	47
RF Stop freq should be greater than IF Stop freq.	47

Remote commands and Instrument Messages

Alphabetical Listing

RPP Tripped	104
Save/recall memory lost.	51
Scale/Div only applies in Log Y Scale	47
Self-test failed	52
Self-test failed; See log file E:\Agilent\Instrument\ CRFSSelfTestLog.txt"	52
Setting conflict; <trigger source> trigger is not available while input is <input port>	54
Setting conflict; Acquisition # Analysis Step # not exist.	54
Setting conflict; Acquisition # not exist.	54
Setting conflict; Acquisition duration time too short, Acq=#	54
Setting conflict; Analysis Interval should be less than ** ms, Acq=# Step=#	54
Setting conflict; Analysis Offset should be greater than # us, Acq=# Step=#.	54
Setting conflict; Auto Set RF Level failed, Too much dynamic range is requested	54
Setting conflict; Averaged acquisition duration time exceeds maximum value, Acq=#	54
Setting conflict; Basic Discrete PAVT measurement cannot be averaged, Acq=# Step=#	54
Setting conflict; Basic IQ data measurement cannot be averaged, Acq=# Step=#	55
Setting conflict; Cannot delete current step, minimum number of steps reached	55
Setting conflict; Cannot insert more steps, maximum number of steps reached	55
Setting conflict; Differential setting determined by probe type.	55
Setting conflict; DUT Expected Power cannot be greater than Peak Power, Acq=# Step=#	55
Setting conflict; Input Z unavailable when probe sensed	55
Setting conflict; Instrument Gain LOW is not supported when frequency > 3.6 GHz. Auto change it to ZERO, Acq=# 55	55
Setting conflict; Measurement Bitmap *** not available in Radio Standard ***, Acq=#	55
Setting conflict; Mod Scheme AutoDet unavailable when Burst Sync=RF Amptd	55
Setting conflict; PAVT step end time exceeds the analysis interval	55
Setting conflict; PAVT step start time is less than zero	55
Setting conflict; Phase Discontinuity measurement cannot be averaged, Acq=# Step=#	56
Setting conflict; Radio Band *** not available in Radio Standard ***, Acq=#.	56
Setting conflict; Radio Device BTS not supported, Acq=#	56
Setting conflict; Radio Standard *** not available, Acq=#.	56
Setting conflict; RF Envelope trace is not available without Basic IQ data measurement, Acq=# Step=#	56

Setting conflict; Transition Time should be greater than # us, Acq=#	56
Setting conflict; Trigger Delay should be greater than # us, Acq=#	56
Setting conflict; Trigger Level is too low, Acq=#	56
Setting conflict;Transition time may be short on step <step number>	56
Setting Modified	95
Setting Modified; Filter not applied	95
Settings Alert	94
Settings Alert; Acquisition truncated	94
Settings Alert; Analog Out settings conflict	94
Settings Alert; Diff probe mismatch; <I Q I,Q>	94
Settings Alert;I/Q mismatch:<Differential Input Z Attenuation>	94
Settings Alert;LO may overload IF	94
Settings Alert;Parm/data mismatch	95
Settings Alert;Span:RBW Ratio too big	95
Settings Alert;Src pwr ramp>ALC range	95
Settings Alert;Sweep Rate Unavailable	95
Settings conflict; *.CSV file format is not available in this measurement	57
Settings conflict; <Q Param> cannot be changed when Q same as I	57
Settings conflict; A Valid User Cal is required. Optimize aborted	57
Settings conflict; Administrator privileges required	66
Settings conflict; Auto Scan Time/Meas Time do not apply in Stepped Scan Type	67
Settings conflict; Auto Tune not available in Tracking Source mode	57
Settings conflict; BTS gain is not available in this Mode	57
Settings conflict; Cal only available when Source Mode is Tracking	57
Settings conflict; Calibration cannot be performed without valid ENR data	57
Settings conflict; Can't Auto-Couple Res BW in Zero Span	58
Settings conflict; Cancellation is not available while measuring DANL floor	57
Settings conflict; Cancellation Ref trace has no data	57
Settings conflict; Cannot accept time or count input when step duration type is Continuous on step #	57
Settings conflict; Cannot optimize while user cal in progress	57
Settings conflict; Carrier freq not allowed with BMT. (Bottom/Middle/Top only)	58

Remote commands and Instrument Messages

Alphabetical Listing

Settings conflict; ClearList & Start not available when ScanSeq = (Re)measure	67
Settings conflict; Continuous Peak is not available with Fixed marker	58
Settings conflict; Continuous Peak is not available with Signal Track on	58
Settings conflict; Destination trace for Trace Math cannot be a trace operand	58
Settings conflict; Downconv only available when DUT is Amplifier	58
Settings conflict; EDGE EVM only supports EDGE TCH burst type.	58
Settings conflict; Electronic attenuator is disabled	58
Settings conflict; Electronic attenuator is not available above 3.6 GHz	58
Settings conflict; Electronic attenuator unavailable in current state	58
Settings conflict; Electronic attenuator unavailable with Preamp on	58
Settings conflict; EMI Detectors and Average detector can't be used together.	67
Settings conflict; EMI Detectors are not available in FFT sweep	58
Settings conflict; Enabled modulation source conflicts with previous modulation source. Previous modulation disabled.	59
Settings conflict; External Mixer not available	59
Settings Conflict; FAST method can only be used while Radio Std is W-CDMA	59
Settings conflict; Feature not available in this View	59
Settings conflict; Feature not supported for selected source	59
Settings conflict; Feature not supported for this Input.	59
Settings conflict; Feature not supported for this measurement.	59
Settings conflict; Feature not supported for this measurement.	59
Settings conflict; Feature not supported for this model number	59
Settings conflict; FFT IF Gain High not available when Swept IF Gain = Manual Low	59
Settings conflict; FFT method is unavailable for level gating	59
Settings conflict; FFT sweep type is not available while in Gated LO	60
Settings conflict; FFT sweep type is not available while in Gated Video	60
Settings conflict; FFT Sweeps unavailable in Tracking Source mode.	60
Settings conflict; Fixed Marker Y value is not adjustable with Normalize On	60
Settings conflict; Freq > 1 GHz is not available while RF Input 2 enabled	67
Settings conflict; Freq > 3.6 GHz unavailable while electronic attenuator enabled	60
Settings conflict; Frequency Offset not available when Frequency Scale is Log	60

Settings conflict; Function not available in External Mixing.	60
Settings conflict; Function not available in Tracking Source mode.	60
Settings conflict; Function not available while measurement is running.	67
Settings conflict; Function only available in Tracking Source mode.	60
Settings conflict; Function unavailable with MW Presel off.	60
Settings conflict; Function unavailable with MW Presel off.	60
Settings conflict; Gate control is Edge for Gated FFT.	60
Settings conflict; Gate control must be Edge for this Gate Source.	60
Settings conflict; Gate is not available when Marker Count on.	61
Settings conflict; Gate Length is not settable in FFT sweeps.	61
Settings conflict; Gate Method is not compatible with current Sweep Type setting.	61
Settings conflict; Gate not available with external Tracking Source.	61
Settings conflict; Gate not available with Tracking Generator.	61
Settings conflict; Gated FFT is not available while Sweep Type is set to Swept.	61
Settings conflict; Gated LO is not available while Sweep Type is set to FFT.	61
Settings conflict; Gated Video is not available while Sweep Type is set to FFT.	61
Settings conflict; Include Source is Yes. ARB memory operation is rejected.	67
Settings conflict; Incorrect RBW for demod. Change RBW.	61
Settings conflict; Ind I/Q is not available for this measurement.	61
Settings conflict; Invalid trace number.	61
Settings conflict; Knob is not available to modify this function.	61
Settings conflict; LO Phase Noise Adj not available.	61
Settings conflict; Log Percent Auto Step Rule does not apply in Swept Scan Type.	67
Settings conflict; Log Scale Type is not available with Demod View.	61
Settings conflict; Log Scale Type is only available in swept measurement.	62
Settings conflict; Marker 1 Trace Update=off turns off Signal Track.	62
Settings conflict; Marker cannot be relative to itself.	62
Settings conflict; Marker Count is not available when Gate on.	62
Settings conflict; Marker Function is not available for a Fixed marker.	62
Settings conflict; Marker type must be delta.	62
Settings conflict; Marker-> function is not available in zero span.	62

Remote commands and Instrument Messages

Alphabetical Listing

Settings conflict; Mask unavailable for current Span. Increase to display mask.	62
Settings conflict; Meas Type was changed to Examine for Exp Avg Mode.	62
Settings conflict; Meas Type was changed to Full for Repeat Avg Mode.	62
Settings Conflict; MinPts/RBW limit not met.	62
Settings conflict; Mkr -> CF is not available when the x-axis is time domain	62
Settings conflict; Mod Scheme AutoDet unavailable when Burst Sync=RF Amptd	62
Settings conflict; MPA GPS port power setting <n>dBm is lower than -130dBm minimum	68
Settings conflict; MPA TX port<n> amplitude correction delta exceeds <n>dB between port<n1> and port<n2>	67
Settings conflict; MPA TX port<n> amplitude correction value <n>dB is out of range. The valid range is <n> ~ <n>dB.	67
Settings conflict; MPA TX port<n> power setting <n>dBm is lower than -130dBm minimum.	68
Settings conflict; MS gain is not available in this Mode	63
Settings conflict; Must apply Amplitude Correction to make this unit available	63
Settings conflict; No meas frequencies are above 3.6 GHz.	63
Settings conflict; no source selected	63
Settings conflict; Normal detector is not allowed with X scale is Log	63
Settings conflict; Normalize is not available when Scale Type = Lin	63
Settings conflict; Normalize is not available while Demod View is on.	63
Settings conflict; Normalize is not available while Trace Math is on	63
Settings conflict; Only active Antenna Unit available; no other Y axis units	63
Settings conflict; Option not available.	63
Settings conflict; Param only available when DUT is a freq converter.	63
Settings conflict; Param only available when External LO Mode is Fixed.	63
Settings conflict; Param only available when External LO Mode is Swept	63
Settings conflict; Param only available when Frequency Mode is Fixed	64
Settings conflict; Param only available when Frequency Mode is Swept.	64
Settings conflict; Param only available when valid cal data exists	64
Settings conflict; Preamp gain is not available in this Mode.	64
Settings conflict; Preamp unavailable with electronic attenuator on.	64
Settings conflict; Pre-trigger is insufficient for demod. Decrease Trig Delay.	64
Settings conflict; QPD + EMI Average + RMS Average is not allowed.	68

Settings conflict; Range <{0}> is turned off as total range points > 40001	68
Settings conflict; Reference marker must be in same window.	64
Settings conflict; Relative Trigger needs hardware support for this meas.	64
Settings conflict; RF Input 2 is not available above 1 GHz.	68
Settings conflict; Scale Type = Lin is not available when Normalize is on	64
Settings conflict; Scan Time & Points do not apply in current Step/Time Control.	68
Settings conflict; Sequence may have gaps when playing step <n>, if next step trigger comes later than current step expires.	64
Settings conflict; Signal Track is not available with Continuous Peak	64
Settings conflict; Signal Track is only available in Swept SA measurement.	64
Settings conflict; Signal Track is turned off when Zero Span is selected	65
Settings conflict; Source List Step<n> MPA GPS port power setting <n>dBm is lower than -130dBm minimum	68
Settings conflict; Source List Step<n> MPA TX port<n> power setting <n>dBm is lower than -130dBm minimum	68
Settings Conflict; Span limited to XXX.	65
Settings conflict; Span Zoom is not available in Zero Span	65
Settings conflict; Span Zoom not available when Frequency Scale Type = Log.	65
Settings conflict; Step duration cannot be set to Play Count when the step is generating a CW tone.	65
Settings conflict; Step keys are not available to modify this function	65
Settings conflict; Step Size & Meas Time do not apply in current Step/Time Control.	69
Settings conflict; Sweep Setup only available in swept measurements	65
Settings conflict; Sweep Time cannot be auto-coupled in FFT sweeps.	65
Settings conflict; Sweep Time cannot be auto-coupled while in Zero Span	65
Settings conflict; Sweep Time cannot be set while in FFT sweeps	65
Settings conflict; Swept IF Gain High not available when FFT IF Gain = Manual Low	65
Settings conflict; Swept LO not available when freq mode is Fixed.	65
Settings conflict; Swept Type=Swept is not available while in Gated FFT.	65
Settings conflict; System Display Settings, Annotation is Off.	66
Settings conflict; T hot must be greater than T cold	66
Settings conflict; The number of input parameters is too large and is truncated to current list step number	66
Settings Conflict; The parameter cannot be changed in FAST mode.	66
Settings conflict; Trace Math is not available while Normalize is on	66

Remote commands and Instrument Messages

Alphabetical Listing

Settings conflict; Tracking Source unavailable in FFT Sweeps	66
Settings conflict; Trigger input in use for source synchronization	66
Settings conflict; Trigger is not available with span > 0 Hz.	66
Settings conflict; Tx Band Spur meas does not support this frequency band.	66
Settings conflict; Tx Band Spur measurement is not defined for mobiles.	66
Settings conflict; Zero Span not available when Frequency Scale Type = Log.	66
Settings conflict;	56
Settings conflict;	74
Settings conflict;function unavailable with this EMC Standard	67
Settings lost due to rtl.	71
Settling	107
Signal ID on	101
Signal List is Empty	71
Signal List is Full	71
Signal Selected is not in the Signal List.	71
Signal Summary	92
Signal Too Noisy	100
Signal Track is turned off when Zero Span is selected	47
Signals deleted	47
Slot Error	100
Slot Error; No idle slot found.	100
Slot error;No active slot found.	100
Source LO Unleveled.	104
Source Sweeping	108
Source Synth Unlocked	105
Source Uncal	103
Source Uncal;adj Start Freq or RBW.	103
Source Unleveled.	104
Source Waiting for Trigger	108
Storage fault;	52
String data error	85

String data not allowed.....	85
Suffix error.....	85
Suffix not allowed.....	85
Suffix too long.....	85
Sweep Points/Span is < minimum. Results may be inaccurate.....	47
Sweep Setup is not available in Zero Span.....	47
Sweeping.....	107
Sync Error.....	98
Sync Error;Midamble sync fail.....	98
Sync Error;No freq ref pilot burst.....	98
Sync Error;No pilot burst.....	98
Sync Error;Preamble length zero.....	98
Sync Error;Sync code not found.....	98
Sync is RF Ampl (not Training Sequence). Bits are not accurate.....	47
Syntax error.....	84
System error; A license will soon expire;<feature code> will expire in <time>.....	50
System Error; enable GPIB controller mode.....	50
System error; Error transmitting a LAN event to the network.....	50
System error; Failed to initialize the PTP clock to current time.....	50
System error; Failed to instantiate the PTP ordinary clock.....	50
System error; feature <feature code> not licensed.....	50
System error; Feature expired; <feature code>.....	50
System error; License installation failed;<feature code>.....	50
System error; License removal failed; <feature code>.....	50
System error; No license; <feature code> will terminate in <time>.....	50
System Error; No supported source found.....	50
System Error; source connection lost, check interface connection.....	51
System error; The configured PTP hardware driver could not be instantiated.....	51
System error; The PTP hardware driver reported a configuration error.....	51
System error; The PTP ordinary clock reported a configuration error.....	51
System error; The Trigger alarm delayed LAN event was not scheduled due to a conflict with an existing scheduled	

Remote commands and Instrument Messages

Alphabetical Listing

alarm.	51
System error; The Trigger alarm delayed LAN event was not scheduled due to an existing pending event.	51
System error; The Trigger alarm was not scheduled due to a conflict with an existing scheduled alarm.	51
System error;	50
Temperature	106
TG Alignment Failure	89
Time out error	53
Time out error; Operation on source is held. If analyzer is waiting for trigger, change to free run to proceed.	53
Timing Error.	98
Timing Error:No time ref pilot burst	98
Too many digits	85
Too much data	74
Too much data; 200 spurs found. Additional spurs ignored.	74
Trace file saved.	47
Trig Error	93
Trigger deadlock	72
Trigger error	71
Trigger ignored.	71
Uncalibrated Summary	92
Undefined header.	84
Unexpected number of parameters	84
unused	90
Use Gate View Sweep Time in the Gate menu.	47
User Cal valid. Apply Cal from Meas Setup menu	47
User cal	101
User Cal; Adjusted for new RBW	103
User Cal; Cal invalidated.	102
User Cal; Cal will be interpolated	103
User Cal; Freq outside cal range	103
User request	48
Waiting for Arm.	108

Waiting for Trigger 108

Remote commands and Instrument Messages

Alphabetical Listing

1 Introduction

The Error and Status messaging system of the Agilent Signal Analyzer reports events and conditions in a consistent fashion, as well as logging and reporting event history.

Event vs. Condition Messages

An **Event** is simply a message indicating that something has happened. Events are sub-divided according to their severity, into Error, Warning or Advisory categories. The sub-divisions are described in more detail in the section [Appendix](#) , “[Event and Condition Categories](#),”.

Event messages appear in the **Message Line** at the bottom left of the analyzer’s display window.

A **Condition** is a state of the Analyzer, which is characterized by a **Detection** event and a **Clearing** event. Conditions may be Errors or Warnings.

Condition messages appear in the **Status Panel** at the bottom right of the analyzer’s display screen.



Event and Condition Categories

The three categories of severity are described below, for both Events and Conditions.

Errors



Error messages appear when a requested operation has failed. (For example, “Detector not available”, “File not saved”.) Error messages are often generated during remote operation when an invalid programming command has been entered. (For example, “Undefined header”.)

Some errors are conditions rather than single events. They exist for a period of time, so they have associated “Detected” and “Cleared” events. (For example, “LO Unlocked” or “External reference out of range”)

Error messages appear in the Status Panel at the bottom of the display. A message remains until you press a key, or another message is displayed in its place.

Error messages are logged in the error queues. If the error is a condition, both the Detected and Cleared events are logged.

Warnings



Warning messages appear when a requested operation has completed successfully, but there are modifications and/or side effects. (For example, if you requested too high a stop frequency, then “Data out of range” is displayed and the analyzer sets itself to the highest available stop frequency.)

Some warnings are conditions rather than single events. They exist for a period of time, so they have a “Detected” event and a “Cleared” event. (For example, if you set the sweep time too fast for a measurement to meet the instrument specifications then the “Meas Uncal” message is displayed until you slow down the sweep time.)

Warning messages appear in the Status Panel at the bottom of the display. The message remains until you press a key, or another message is displayed in its place.

Warnings are logged in the error queues. If the warning is a condition, both the Detected and Cleared event messages are logged.

Advisories



Advisory messages tell the front panel user some useful information. (For example, “File saved successfully” or “Measuring the fundamental”.)

Advisory messages appear in the Status Panel at the bottom of the display. The message remains until you press a key, or another message is displayed in its place.

Advisory messages are not logged in the error queues.

Grayout messages are a special type of Advisory, which appear when you attempt to access a function that is not available. This could be a grayed out front panel key, or an inappropriate SCPI command. There are two types of grayout messages: Benign and Forced.

1. **Benign:** the requested function is not available because it does not make sense with the current instrument settings. Changing it does not affect the current measurement. (For example, setting the number of FFTs/Span when you are not in the FFT mode.)

A benign grayout gives an Advisory type of message only when the front panel key is pressed.

The requested function cannot be changed from the front panel, but it can be changed remotely.

2. **Forced:** the requested function is not available either because changing it would cause an invalid measurement, or because of hardware limitations, or because the selection conflicts with other settings. (For example, selecting the electrical attenuator when the frequency span includes frequencies above 3.6 GHz.)

A forced grayout function cannot be changed either from the front panel or remotely. It generates a special type of Advisory message. It also only appears on the front panel when the key is pressed. Remotely, the message will appear in the event queue as a warning “-221, Settings conflict; <conflict description>”.

Event Message Format

The event messages are listed in numerical order according to their message number. Advisory messages do not have numbers, and are listed in alphabetical order.

An explanation is included with each error to further clarify its meaning. Some errors are specified in industry standards and there are references to the IEEE Standard 488.2-1992, *IEEE Standard Codes, Formats, Protocols and Common Commands for Use with ANSI/IEEE Std 488.1-1987*. New York, NY, 1992.

Figure 1-1 Error Message Example

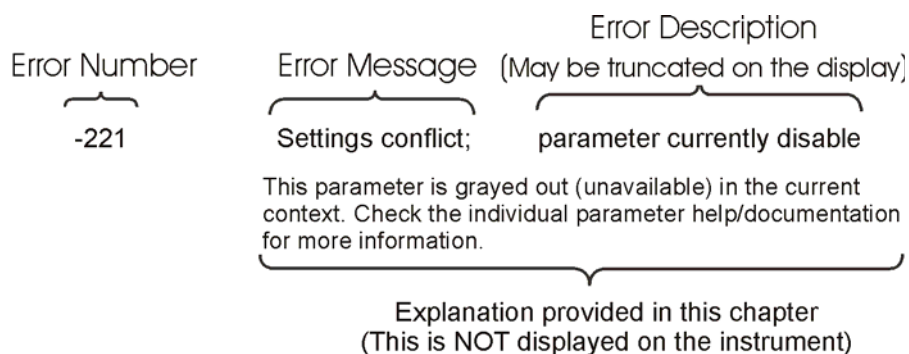

pk716b

Event Queues

There are several different event queues that are viewed/queried and managed separately. Note that Conditions are logged in the queues as pairs of events: a “Detected” event and a corresponding “Cleared” event.

Front Panel Status	Error messages can be viewed by pressing, System, Show Errors, Status . The Status screen shows error conditions that currently exist. When an error event is caused by a command sent over a remote interface, the resulting messages are logged in the queue for that interface. For convenience, they are also logged in the front panel queue.
Front Panel History	Error messages can be viewed by pressing, System, Show Errors, History . The History screen shows all the error events that have occurred since the instrument was turned on, with a maximum of 100 messages. When an error situation is caused by a command sent over a remote interface, the resulting messages are logged in the queue for that interface. For convenience, they are also logged in the front panel queue.
Remote interfaces (GPIB/LAN)	When an error event is caused by a command sent over a remote interface, the resulting messages are output to the queue for that interface. To return an error, you must query the queue for that interface. An error event that is caused by a front panel action is not reported to any remote interface queue. However, a status condition is usually caused by an internal event that is not related to a particular interface, so the Detected/Cleared events for status conditions are reported to all the error queues.

Table 1-1 Characteristics of the Event Queues

Characteristic	Front-Panel Status	Front-Panel History	Remote Interfaces (GPIB/LAN)
Capacity (maximum number of messages)	100	100	100
Overflow Handling	Circular (rotating). Drops oldest error as new error comes in.	Circular (rotating). Drops oldest error as new error comes in.	Linear, first-in/first-out. Replaces newest error with: -350, Queue overflow
Viewing Entries	Press: System, Show Errors, Status	Press: System, Show Errors, History	Send SCPI query to the desired interface. SYSTem:ERRor?
Clearing the Queue	Press: System, Show Errors, Clear Error Queue Clears the errors in all the queues.	Press: System, Show Errors, Clear Error Queue Clears the errors in all the queues.	Send *CLS command to the desired interface. Clears errors in the queue for this particular interface only.

Table 1-2 Summary of Event Reporting Modes

Event Type	SCPI Error Queues	Front Panel History Queue	Status Panel Display
Error Event	Logged	Logged	Displayed in Message Line
Warning Event	Logged	Logged	Displayed in Message Line
Advisory Event	Logged	Logged	Displayed in Message Line
Error Condition Detected	Logged	Logged	Displayed in Status Line
Error Condition Cleared	Logged		
Warning Condition Detected	Logged	Logged	Displayed in Status Line
Warning Condition Cleared	Logged		
Grayout Advisory (Benign)	Not logged	Logged	Displayed in Message Line
Grayout Advisory (Forced)	See note ^a	Logged	Displayed in Message Line

a. Not logged, unless the cause of the Advisory was remotely generated, in which case a Warning message, type –221, is logged.

Advisory Messages

An advisory is simply a message that lets you know something useful - for example “File saved successfully” or “Measuring fundamental.” Operation completion and running status indications are common types of advisories. Advisories have no number and are not logged in the error queue.

Advisories include gray-out “settings conflict” errors. These gray-outs are benign (i.e. changing them has no impact on the current measurement).

Advisories are event-type errors only. They are never conditions.

Message	Description/Correction Information
All Auto/Man functions have been set to Auto	
All Auto/Man functions have been set to Auto.	Message generated by pressing the Auto Couple front-panel key.
Allowable Center Frequency exceeded for the current span	When rotating the knob or step up/down keys to change the Center frequency, the value of the Span is kept constant. Therefore, the center frequency is limited by the frequency range of the instrument.
Allowable Span exceeded for the current center frequency	When rotating the knob or step up/down keys to change the Span, the value of the Center frequency is kept constant. Therefore, the span is limited by the frequency range of the instrument.
Allowable Start Frequency exceeded for the current span	When rotating the knob or step up/down keys to change the Start frequency, the value of the Span is kept constant. Therefore, the start frequency is limited by the frequency range of the instrument.
Allowable Stop frequency exceeded for the current span	When rotating the knob or step up/down keys to change the Stop frequency, the value of the Span is kept constant. Therefore, the stop frequency is limited by the frequency range of the instrument.
Already in Single, press Restart to initiate a new sweep or sequence	The instrument is already in the single state. If you want to start a new sweep or sequence, press the Restart key instead.
Auto sweep time rules do not apply in FFT sweeps	FFT sweeps do not use the auto sweep time rules, so the rules setting cannot be changed from the front panel. The setting can be changed remotely and it will have no effect on the current operation unless the analyzer is switched out of FFT sweeps.
Band Adjust has no effect on a Fixed marker	If a Marker is a Fixed type marker, the marker's value does not change from when it first became fixed. So you cannot change the band of a fixed marker.

Message	Description/Correction Information
Band Adjust has no effect with Mkr Function Off	If Marker Function is off changing the band has no effect
Band-pass filter set to OFF	Turning on any high-pass or low-pass filter will turn off band pass filters.
Cal Cancelled; Calibration data cleared	User has cancelled the cal either directly or indirectly by changing the setup parameters. The current cal data has been erased. Perform a new user cal to obtain calibrated results again.
Cal Invalid: meas freq pt(s) > 3.6GHz are > 50MHz from existing Cal pts	When freq points being measured are above 3.6 GHz and a calibration has been successfully performed, and the number of points are changed, the new points are required to be within 50 MHz of the current cal points or the preselector optimize frequencies become inaccurate and the whole cal needs to be invalidated. Interpolation of the cal can only be performed if the new freq points are within 50 MHz of the cal points. To overcome this problem, change the number of freq points back to match cal points or perform another user cal.
Carrier power is too low for optimum dynamic range.	For better dynamic range, transmit band spur measurements require >10 dBm signal power at the RF input port.
Connecting to source...	External Signal Generator is being sent SCPI commands interrogating it to see if it is suitable for the MXA to control. Please wait until complete before pressing any buttons.
Demod Time is not available in Zero Span	The Demod Time function is not available in zero span because in zero span we are ALWAYS demodulating.
Detector <X> changed due to physical constraints	You have selected more detectors than the instrument hardware can implement. An existing detector selection has been changed to allow the current detector choice to be selected. <X> indicates the trace number for which the detector was changed.
Dynamic range is not optimum. Set AUTO RF input.	
Exp. Averaging not available when AUTO PhNoise is active.	
FFT Width is not settable unless Sweep Type is set to FFT	You must select the FFT sweep type before you can set the FFT Width
File <filename> saved	The file save operation executed successfully.
Filter BW function is only available for Gaussian filter type	Flattop and CISPR/MIL filters have defined shapes that cannot be altered. So only the Gaussian filter type allows filter bandwidth definition changes.

Instrument Messages
Advisory Messages

Message	Description/Correction Information
Fixed LO freq should be greater than RF Stop freq	The setup frequencies break the rules for a downconverter measurement. The measurement will still run, but check setup frequencies are correct before continuing. The LO fixed freq should be greater than the RF freq's for an LSB or DSB (for DSB measurements the setup uses LSB values) downconverter setup. Use the graph icon on the DUT setup form to clarify the setup required.
Freq Scale Type=Log is not available in Zero Span	Logarithmic scaling cannot be used for time domain sweeps (0 Hz span).
Frequency Hopping enabled, waiting for valid burst	The demodulated burst type has not been found in the originally demodulated slot location within the frame.
Frequency menu has changed to reflect frequency context switch	The frequency context parameter has been changed by either the user or the system. The frequency menu will now contain the frequencies for the new context. No action required.
Gate required for valid results	
High-pass and Low-pass filters set to OFF	Turning on any band pass filter will turn off high-pass and low-pass filters.
High-pass filter set to OFF	Turning on any band pass filter will turn off high-pass filters.
IF Fixed freq should be greater than LO Stop freq	The setup frequencies break the rules for an upconverter measurement. The measurement will still run, but check setup frequencies are correct before continuing. The IF fixed freq should be greater than the LO Stop freq for a USB upconverter swept LO setup. Use the graph icon on the DUT setup form to clarify the setup required.
IF Fixed freq should be greater than RF Stop freq	The setup frequencies break the rules for an upconverter measurement. The measurement will still run, but check setup frequencies are correct before continuing. The IF fixed freq should be greater than the RF Stop freq for an upconverter swept LO setup. Use the graph icon on the DUT setup form to clarify the setup required.
IF Start freq should be greater than LO Fixed freq	The setup frequencies break the rules for an upconverter measurement. The measurement will still run, but check setup frequencies are correct before continuing. The IF start freq should be greater than the LO fixed freq for an USB upconverter fixed LO setup. Use the graph icon on the DUT setup form to clarify the setup required.
IF Start freq should be greater than RF Start freq	The setup frequencies break the rules for an upconverter measurement. The measurement will still run, but check setup frequencies are correct before continuing. The IF start freq should be greater than the RF Start freq for an upconverter fixed LO setup. Use the graph icon on the DUT setup form to clarify the setup required.

Message	Description/Correction Information
Input is internal	The instrument's input is set to internal (the internal amplitude reference signal). So any signals connected to the front/rear panel inputs cannot be measured.
LO Fixed freq should be greater than IF Stop freq	The setup frequencies break the rules for an upconverter measurement. The measurement will still run, but check setup frequencies are correct before continuing. The LO fixed freq should be greater than the IF Stop freq for an LSB upconverter fixed LO setup. Use the graph icon on the DUT setup form to clarify the setup required.
LO Fixed freq should be greater than RF Stop freq	The setup frequencies break the rules for a downconverter measurement. The measurement will still run, but check setup frequencies are correct before continuing. The LO fixed freq should be greater than the RF Stop freq's for an LSB or DSB (for DSB measurements the setup uses LSB values) downconverter fixed LO setup. Use the graph icon on the DUT setup form to clarify the setup required.
LO Start freq should be greater than IF Fixed freq	The setup frequencies break the rules for an upconverter measurement. The measurement will still run, but check setup frequencies are correct before continuing. The LO Start freq should be greater than the IF fixed freq for an LSB upconverter swept LO setup. Use the graph icon on the DUT setup form to clarify the setup required.
LO Start freq should be greater than RF Start freq	The setup frequencies break the rules for a downconverter measurement. The measurement will still run, but check setup frequencies are correct before continuing. The LO start freq should be greater than the RF Start freq's for an LSB downconverter swept LO setup. Use the graph icon on the DUT setup form to clarify the setup required.
LO Stop freq should be greater than RF Stop freq	The setup frequencies break the rules for a downconverter measurement. The measurement will still run, but check setup frequencies are correct before continuing. The LO Stop freq should be greater than the RF Stop freq's for a DSB (for DSB measurements the setup uses LSB values) downconverter swept LO setup. Use the graph icon on the DUT setup form to clarify the setup required.
Low-pass filter set to OFF	Turning on any band pass filter will turn off low-pass filters.
No spurs have been found	You has started a measurement in examine meas type in single or continual sweep mode, or full meas type in single sweep mode, but no spurs were found.
Preparing Calculation..	
Preselector is centered	The preselector has been successfully centered

Instrument Messages
 Advisory Messages

Message	Description/Correction Information
Preselector not used in this frequency range.	You cannot center or adjust the preselector because it is not used at all at the current marker frequency or between the current start and stop frequencies
Probe connected, cal data is being reapplied; <port>; <probe>	A probe has been connected, calibration data is being reapplied
Probe connected, no probe cal; using cable cal data; <port>; <probe>	A probe has been connected and no probe calibration data is available. The latest cable calibration data will be used
Probe disconnected, reverting to cable calibration data; <port>	A probe has been disconnected, calibration data reverting to the last cable calibration data
Reading SNS data...	The Agilent Smart Noise Source has been connected and the application is reading the device EEPROM data. Please wait until complete before continuing.
Recalled File <filename>	A file recall (open/load) was successfully completed.
Refer to online help for assistance with DSB measurements	The Double Side Band measurement requires careful setup to obtain valid results. Please refer to the manuals for help with this setup.
Requested timeslot number is not present.	The selected timeslot is not on. (Timeslot is referenced to the trigger point.)
RF Start freq should be greater than IF Fixed freq	The setup frequencies break the rules for a downconverter measurement. The measurement will still run, but check setup frequencies are correct before continuing. The RF Start freq should be greater than the IF Fixed freq for a DSB (for DSB measurements the setup uses LSB values) downconverter swept LO setup. Use the graph icon on the DUT setup form to clarify the setup required.
RF Start freq should be greater than IF start freq	The setup frequencies break the rules for a downconverter measurement. The measurement will still run, but check setup frequencies are correct before continuing. The RF start freq should be greater than the IF Start freq's for an LSB downconverter fixed LO setup. Use the graph icon on the DUT setup form to clarify the setup required.
RF Start freq should be greater than LO fixed freq	The setup frequencies break the rules for a downconverter measurement. The measurement will still run, but check setup frequencies are correct before continuing. The RF start freq should be greater than the LO fixed freq's for an USB downconverter fixed LO setup. Use the graph icon on the DUT setup form to clarify the setup required.

Message	Description/Correction Information
RF Start freq should be greater than LO Start freq	The setup frequencies break the rules for a downconverter measurement. The measurement will still run, but check setup frequencies are correct before continuing. The RF start freq should be greater than the LO Start freq's for an USB downconverter swept LO setup. Use the graph icon on the DUT setup form to clarify the setup required.
RF Stop freq should be greater than IF Stop freq	The setup frequencies break the rules for a downconverter measurement. The measurement will still run, but check setup frequencies are correct before continuing. The RF Stop freq should be greater than the IF Stop freq's for an USB or DSB (for DSB measurements the setup uses LSB values) downconverter fixed LO setup. Use the graph icon on the DUT setup form to clarify the setup required.
Scale/Div only applies in Log Y Scale	Setting the Scale/Division only makes sense when you are using a logarithmic Y scale.
Signal Track is turned off when Zero Span is selected	Signal Track is not available when you have selected Zero Span. So if Zero Span is entered while in Signal Track is On, Signal Track is turned off.
Signals deleted	The signals in the signal list were successfully deleted.
Sweep Points/Span is < minimum. Results may be inaccurate.	The sweep point to span ratio is below the minimum required to ensure the bucket ratio is large enough to test DVB-T masks
Sweep Setup is not available in Zero Span	Zero span is a display at a single frequency, so there is no "sweeping" to set up.
Sync is RF Ampl (not Training Sequence). Bits are not accurate.	
Trace file saved.	The trace saving operation was successful.
Use Gate View Sweep Time in the Gate menu.	When in Gate View you use Gate View Sweep Time, rather than Sweep Time, to control the Gate View window
User Cal valid. Apply Cal from Meas Setup menu	The measurement setup has changed such that the current cal data can be applied to the results. To apply the cal, press Meas Setup/Cal Setup/Apply Calibration. A new cal can be performed if required.

Event Messages

Event messages read out in the MSG area in the bottom left of the display. Event messages and message numbers are defined by the SCPI standard.

In the X-Series, sub-messages are often attached to add additional information, to help the user better understand the event being reported. For example, error –221 is defined as “Settings Conflict”, but in the X-Series you will often see a longer message with error –221, such as “Settings Conflict; Function not available in Zero Span”. This helps you understand exactly why you are getting a Settings Conflict error.

–800, Operation Complete Event

Err#	Message	Verbose/Correction Information
–800	Operation complete	The instrument has completed all selected pending operations in accordance with the IEEE 488.2, 12.5.2 synchronization protocol.
–800	Operation complete; Loaded <ARB filename> successfully, but no license <required licenses> installed	This is a warning, and is GUI only, i.e. this warning cannot be queried by SCPI. It indicates that the ARB is successfully loaded into ARB memory, but requires licenses that are not present on the instrument. Install the required license(s) according to <required license> string to license it or multi-pack license it.

–700, Request Control Event

Err#	Message	Verbose/Correction Information
–700	Request control	The instrument requested to become the active IEEE 4881 controller-in-charge.

–600, User Request Event

Err#	Message	Verbose/Correction Information
–600	User request	The instrument has detected the activation of a user request local control.

-500, Power on Event

Err#	Message	Verbose/Correction Information
-500	Power on	The instrument has detected an off to on transition in its power supply.

-400 to -499, Query Errors

Err#	Message	Verbose/Correction Information
-400	Query Error	There was a problem with a query command. The exact problem cannot be specifically identified.
-410	Query INTERRUPTED	Some condition caused an INTERRUPTED query to occur. For example, a query was followed by DAB or GET before a response was completely sent.
-420	Query UNTERMINATED	Some condition caused an UNTERMINATED query to occur. For example, the device was addressed to talk and an incomplete program message was received.
-430	Query DEADLOCKED	Some condition caused a DEADLOCKED query to occur. For example, both the input buffer and the output buffer are full and the analyzer cannot continue. The analyzer automatically discards output to correct the deadlock.
-440	Query UNTERMINATED after indefinite response	A query was received in the same program message after a query requesting an indefinite response was executed.

-300 to -399, Device-Specific Errors

Err#	Message	Verbose/Correction Information
-300	Device-specific error	An instrument error occurred and the exact problem cannot be specifically identified. Report this error to the nearest Agilent Technologies sales or service office.
-310	System error;	An internal system-type error has occurred. The exact problem cannot be specifically identified. Report this error to the nearest Agilent Technologies sales or service office.
-310	System error; A license will soon expire; <feature code> will expire in <time>	The indicated feature/software will expire in the specified time. Contact Agilent Technologies to purchase continued use of this functionality.
-310	System Error; enable GPIB controller mode	Press System, I/O Config, GPIB and set GPIB Controller to Enabled so that the analyzer can control the source over GPIB
-310	System error; Error transmitting a LAN event to the network.	Communication with the network driver failed.
-310	System error; Failed to initialize the PTP clock to current time.	Failure communicating with the DMC libraries' PTP controller.
-310	System error; Failed to instantiate the PTP ordinary clock.	Failure in the starting up the DMC libraries' PTP controller.
-310	System error; feature <feature code> not licensed	The specified feature, for example "N9073A-TR2" is not licensed. The license may have expired. You cannot use it until you get a license.
-310	System error; Feature expired; <feature code>	The specified feature has expired. The license is no longer valid.
-310	System error; License installation failed; <feature code>	The license installation of the specified feature, for example "N9073A-TR2", has failed. You should refer to the event log in the control panel for more details.
-310	System error; License removal failed; <feature code>	The license removal of the specified feature, for example "N9073A-TR2" has failed. You should refer to the event log in the control panel for more details.
-310	System error; No license; <feature code> will terminate in <time>	The specified feature will stop working in the specified time due to the license expiration You will be prompted to save results and exit.
-310	System Error; No supported source found	Signal source at given IP address is not responding / IP does not belong to a source. Check IP address and network connection.

Err#	Message	Verbose/Correction Information
-310	System Error; source connection lost, check interface connection	Signal source at given IP address is not responding / IP does not belong to a source. Check IP address and network connection.
-310	System error; The configured PTP hardware driver could not be instantiated.	The PTP driver failed on initialization.
-310	System error; The PTP hardware driver reported a configuration error.	Failure in the execution of the PTP driver. The most likely cause of this error is a mismatch between versions of the PTP driver and the LXI middleware.
-310	System error; The PTP ordinary clock reported a configuration error.	Failure in execution of the DMC libraries' PTP controller.
-310	System error; The Trigger alarm delayed LAN event was not scheduled due to an existing pending event.	Delayed LAN events cannot occur too close together (within 20 ms).
-310	System error; The Trigger alarm delayed LAN event was not scheduled due to a conflict with an existing scheduled alarm.	Delayed LAN events cannot occur too close to a scheduled Alarm (within 20 ms).
-310	System error; The Trigger alarm was not scheduled due to a conflict with an existing scheduled alarm.	Alarms cannot be scheduled to happen too close together (within 20 ms).
-311	Memory error	There is a physical problem with the instrument memory, such as a parity error.
-312	PUD memory lost	Protected user data saved by the *PUD command has been lost.
-313	Calibration memory lost	The nonvolatile calibration data used by the *CAL? command has been lost.
-314	Save/recall memory lost	The nonvolatile data saved by the *SAV? command has been lost.
-315	Configuration memory lost	The nonvolatile configuration data saved by the instrument has been lost.

Instrument Messages
Event Messages

Err#	Message	Verbose/Correction Information
-320	Storage fault;	A problem was found while using data storage. The error is not an indication of physical damage or failure of any mass storage element.
-321	Out of memory	An internal operation needed more memory than was available. Report this error to the nearest Agilent Technologies sales or service office.
-321	Out of memory; Results truncated	The result array is truncated because it is too large. Reduce the acquisition count, analysis step count, or measurement count.
-321	Out of memory; Sequence too long	The Sequence is too large to be captured. Reduce the Number of Acquisitions or the Acquisition Duration of each Acquisition.
-321	Out of memory; Total analysis step reaches its limitation	Due to the internal limitation, we only support a maximum of 1000 analysis steps. Reduce the analysis steps count.
-330	Self-test failed	A self-test failure occurred. Report this error to the nearest Agilent Technologies sales or service office.
-330	Self-test failed; See log file E:\Agilent\Instrument\ CRFSSelfTestLog.txt"	Source self test fails. There is a source hardware check failure, see test summary file for detail and contact Agilent for support.
-340	Calibration failed	The instrument requires an Align All Now. Restore the alignment by pressing System, Alignments, Align All Now.
-340	Calibration failed; no signal detected; <port>	The calibration for the <I I-bar Q Q-bar> port did not succeed because the calibration signal was not detected. Check that the < I I-bar Q Q-bar > port is properly connected to the Cal Out port.
-350	Queue overflow	An error occurred that did not get put in the error queue because the queue was full.
-360	Communication error	There was a problem with instrument remote communications. The exact problem cannot be specifically identified.
-360	Communication error; SNS data read failure. Disconnect then reconnect SNS	The Agilent Smart Noise Source connected to the MXA has failed to be read by the application. Please disconnect and reconnect the SNS. If this continues to fail, then the SNS may have had its EEPROM corrupted or another hardware fault exists. Check SNS on another instrument, NFA and ESA are also SNS compatible instruments. Check the device is not an Agilent power sensor which uses the same cable interface.

Err#	Message	Verbose/Correction Information
-360	Communication error; SNS is not connected	The Agilent Smart Noise Source connected to the MXA has failed to be read by the application. Please disconnect and reconnect the SNS. If this continues to fail, then the SNS may have had its EEPROM corrupted or another hardware fault exists. Check SNS on another instrument, NFA and ESA are also SNS compatible instruments. Check the device is not an Agilent power sensor which uses the same cable interface.
-361	Parity error in program message	A parity bit was not correct when the data was received. For example, on a parallel port.
-362	Framing error in program message	A stop bit was not detected when data was received. For example, on a remote bus port.
-363	Input buffer overrun	A software or hardware input buffer on a port overflowed with data because of improper or nonexistent pacing.
-365	Time out error	There was a time-out problem in the instrument. The exact problem cannot be specifically identified.
-365	Time out error; Operation on source is held. If analyzer is waiting for trigger, change to free run to proceed	<p>This is a warning message.</p> <p>This warning can only occur when issuing SCPI to operate the source while the analyzer is waiting for a trigger. When the analyzer is waiting for a trigger source operation is set to pending. (Trigger Source operation is an exception)</p> <p>To avoid this, do not operate the source when the analyzer is waiting for a trigger. If both the source and analyzer are utilized, configure the source parameters ready and run before analyzer waits for trigger.</p> <p>If both the analyzer and source are waiting for a trigger, the only operations allowed on the source are trigger source operations, like external, manual, or bus trigger to trigger source.</p>

-221 Settings Conflict Errors

This is one of the errors in the standard SCPI error range of -200 to -299. See the table “-200 to -299, Execution Errors” on page 69.

The <subtext> part of a Settings Conflict error should be worded so that the text is: “function1” is not whatever/with/while/when “function2”. This makes them easier to find - alphabetically, to avoid duplicates.

The entire message displays in the error history as “-221, Settings conflict; <subtext>”

For example, -221.0076 displays as:

Instrument Messages
Event Messages

-221, Settings conflict; Invalid trace number

Err#	Message	Verbose/Correction Information
-221	De-emphasis only available in FM	The de-emphasis function is only available if FM demod is selected.
-221	Function not available in Zero Span	The function you are trying to access is not available in zero span.
-221	Setting conflict; <trigger source> trigger is not available while input is <input port>	The trigger source (Video, RF Burst, I/Q Mag, etc.) is not available with the current input port (RF, IQ, etc.)
-221	Setting conflict; Acquisition # Analysis Step # not exist	The configured Analysis Step does not exist. Add the specified analysis step into the sequence.
-221	Setting conflict; Acquisition # not exist.	The configured acquisition does not exist. Add the specified acquisition into this sequence.
-221	Setting conflict; Acquisition duration time too short, Acq=#	Acquisition duration cannot be less than (analysis offset + analysis interval). Increase the acquisition duration time or decrease the analysis offset and analysis interval.
-221	Setting conflict; Analysis Interval should be less than ** ms, Acq=# Step=#	The analysis interval is too large for basic transmit power measurement. Decrease the analysis interval.
-221	Setting conflict; Analysis Offset should be greater than # us, Acq=# Step=#	The Analysis Offset should be greater than # μ s due to physics requirement. Increase the time of Analysis Offset.
-221	Setting conflict; Auto Set RF Level failed, Too much dynamic range is requested	The sequence requests too much dynamic range; auto range cannot be performed correctly. Change the Peak Power or DUT Expected Power.
-221	Setting conflict; Averaged acquisition duration time exceeds maximum value, Acq=#	Total acquisition duration time after averaging (average count * acquisition duration) exceeds maximum value. Reduce the average count or decrease the acquisition duration time.
-221	Setting conflict; Basic Discrete PAVT measurement cannot be averaged, Acq=# Step=#	The average count of acquisition which contains basic Discrete PAVT measurement cannot be greater than 1. Set the average count of current acquisition to 1. Or remove the Basic Discrete PAVT measurement from this analysis step.

Err#	Message	Verbose/Correction Information
-221	Setting conflict; Basic IQ data measurement cannot be averaged, Acq=# Step=#	The average count of acquisition which contains basic IQ data measurement cannot be greater than 1. Set the average count of current acquisition to 1. Or remove the Basic IQ data measurement from this analysis step.
-221	Setting conflict; Cannot delete current step, minimum number of steps reached	An attempt was made to delete the current step which is already the only step in the list sequence.
-221	Setting conflict; Cannot insert more steps, maximum number of steps reached	An attempt was made to insert more steps into list sequence which already contains the maximum of 1000 steps.
-221	Setting conflict; Differential setting determined by probe type	A probe is connected that has a built in Differential setting. The setting cannot be changed manually.
-221	Setting conflict; DUT Expected Power cannot be greater than Peak Power, Acq=# Step=#	Changing Peak Power will cause DUT Expected Power to be clipped. This is a warning message, no action is required.
-221	Setting conflict; Input Z unavailable when probe sensed	A probe is connected and the Input Z is set based on the probe type. It cannot be changed manually.
-221	Setting conflict; Instrument Gain LOW is not supported when frequency > 3.6 GHz. Auto change it to ZERO, Acq=#	When the acquisition frequency is change to be greater than 3.6 GHz, the Instrument Gain will be set to ZERO automatically if the current value is LOW. This is a warning message, no action is required.
-221	Setting conflict; Measurement Bitmap *** not available in Radio Standard ***, Acq=#	The configured measurement is not supported by the current radio standard. Remove this measurement from the current acquisition or change the radio standard of the current acquisition.
-221	Setting conflict; Mod Scheme AutoDet unavailable when Burst Sync=RF Amptd	The end time of PAVT measurement exceeds the analysis interval. Decrease the end time of PAVT or increase the Analysis interval.
-221	Setting conflict; PAVT step end time exceeds the analysis interval	The end time of PAVT measurement exceeds the analysis interval. Decrease the end time of PAVT or increase the Analysis interval.
-221	Setting conflict; PAVT step start time is less than zero	The start time of PAVT measurement cannot be less than ZERO.

Instrument Messages
Event Messages

Err#	Message	Verbose/Correction Information
-221	Setting conflict; Phase Discontinuity measurement cannot be averaged, Acq=# Step=#	The average count of acquisition which contains Phase Discontinuity measurement cannot be greater than 1. Set the average count of current acquisition to 1. Or remove the Phase Discontinuity measurement from this analysis step.
-221	Setting conflict; Radio Band *** not available in Radio Standard ***, Acq=#	The radio band is not supported by the selected Radio Standard. Change the radio band.
-221	Setting conflict; Radio Device BTS not supported, Acq=#	Sequence analyzer does not support BTS. Change the device type of the acquisition radio standard related mode to MS. For example: if acquisition 3 is configured as WCDMA, so you should change the device type of WCDMA mode to MS.
-221	Setting conflict; Radio Standard *** not available, Acq=#	The radio standard related application is not preloaded. Manually switch to the radio standard related mode and switch back to Sequence Analyzer mode. Or select this mode as preloaded in configure-application panel and then restart.
-221	Setting conflict; RF Envelope trace is not available without Basic IQ data measurement, Acq=# Step=#	RF envelope view is available only when the selected analysis step contains Basic IQ data measurement. Configure Basic IQ data measurement into current analysis step or switch the view to Result Metrics.
-221	Setting conflict; Transition Time should be greater than # us, Acq=#	The transition time of acquisition # should be greater than physics required minimum time. Increase the transition time.
-221	Setting conflict; Trigger Delay should be greater than # us, Acq=#	The trigger delay of acquisition # should be greater than physics required minimum time. Increase the time of trigger delay.
-221	Setting conflict; Trigger Level is too low, Acq=#	The Trigger Level on the specified Acquisition is too low, so that the test-set cannot be triggered correctly. Increase the trigger level.
-221	Setting conflict; Transition time may be short on step <step number>.	An attempt was made to set the source step transition time to a value shorter than hardware settling time. This is provided as a warning. Instrument operation may not be impacted because the hardware could settle more quickly than is normal. You can eliminate this warning by setting a longer transition time.
-221	Settings conflict;	A legal command was received but it could not be executed due to the current device state.

Err#	Message	Verbose/Correction Information
-221	Settings conflict; <Q Param> cannot be changed when Q same as I	When the "Q Same as I" parameter is set to Yes, the I parameter value is copied to <Q Param> and the <Q Param> value cannot be changed. Set Q Same as I to No to enable explicit control of the <Q Param> value.
-221	Settings conflict; *.CSV file format is not available in this measurement.	You cannot load or save base instrument traces, as this is not supported by the Log Plot measurement.
-221	Settings conflict; A Valid User Cal is required. Optimize aborted	Optimize Preselector can only be performed if a valid user cal exists and is applied to current results. Perform a user cal first or apply existing cal.
-221	Settings conflict; Auto Tune not available in Tracking Source mode	The Auto Tune feature cannot be used when you are using a Tracking Source.
-221	Settings conflict; BTS gain is not available in this Mode	Base Transceiver Station gain correction is not available in some Modes, or in some measurements (for example, the SA measurement).
-221	Settings conflict; Cal only available when Source Mode is Tracking	You must be in Tracking Source mode to use the Cal functions under Normalize. Press Source, Source Mode and set it to Tracking.
-221	Settings conflict; Cannot accept time or count input when step duration type is Continuous on step #	An attempt to set list sequence some one step's "Duration Time" or "Play Count" when that step's "Duration Type" is "Continuous". This error can only occur on SCPI input. Set that step's "Duration Type" to "Play Count" or "Duration Time" first then setup count or time.
-221	Settings conflict; Calibration cannot be performed without valid ENR data	The cal ENR table has no values in it, and hence the cal cannot be performed. Correct by either populating the cal ENR table, set ENR mode to Spot, or set the 'Use Meas Table Data for Cal' to 'On'.
-221	Settings conflict; Cancellation is not available while measuring DANL floor.	Phase Noise cancellation does not make sense when measuring the DANL Floor, so for this reason it has been disabled
-221	Settings conflict; Cancellation Ref trace has no data.	When performing phase noise cancellation, you need to supply a reference trace that will be used to cancel out the background noise of the analyzer. The reference trace must be in Reference (View) mode, and selected by the Ref Trace parameter under the Cancellation menu
-221	Settings conflict; Cannot optimize while user cal in progress	Optimize Preselector cannot be performed while a user cal is in progress. The user cal performs an optimize preselector prior to taking the noise source on/off level results for the cal data.

Instrument Messages
Event Messages

Err#	Message	Verbose/Correction Information
-221	Settings conflict; Can't Auto-Couple Res BW in Zero Span	The resolution bandwidth cannot be set to auto while you are in zero span (time domain).
-221	Settings conflict; Carrier freq not allowed with BMT. (Bottom/Middle/Top only)	The transmit band spur measurement only allows bottom (B), middle (M), and top (T) channel frequencies for each supported frequency band. The carrier frequency must be set to the bottom, middle, or top frequency of the current frequency band.
-221	Settings conflict; Continuous Peak is not available with Fixed marker	The continuous peak feature cannot be used with a marker that is fixed. By definition that marker value cannot change.
-221	Settings conflict; Continuous Peak is not available with Signal Track on	The continuous peak feature cannot be used while you are also using the signal tracking function.
-221	Settings conflict; Destination trace for Trace Math cannot be a trace operand	The resulting trace data (from doing a trace math function) cannot be put into the any of the traces that are being used by the math operation.
-221	Settings conflict; Downconv only available when DUT is Amplifier	SCPI only message. The System Downconverter can only be set to 'On' when the DUT type is amplifier. Change DUT type to Amplifier if the System Downconverter is required.
-221	Settings conflict; EDGE EVM only supports EDGE TCH burst type.	
-221	Settings conflict; Electronic attenuator is disabled	You are using the mechanical attenuator, and have not enabled the electronic attenuator. You cannot set the value of the electronic attenuator because it automatically sets/changes when enabled.
-221	Settings conflict; Electronic attenuator is not available above 3.6 GHz	The maximum frequency of the electronic attenuator is 3.6 GHz. This is because of switching capacitance.
-221	Settings conflict; Electronic attenuator unavailable in current state	
-221	Settings conflict; Electronic attenuator unavailable with Preamp on	The internal preamp is on. Electronic attenuator cannot be used while you are using the internal preamp.
-221	Settings conflict; EMI Detectors are not available in FFT sweep	QPD, EMI Average, EMI Peak, and MIL Peak are not allowed when in the manually selected FFT sweep mode.

Err#	Message	Verbose/Correction Information
-221	Settings conflict; External Mixer not available	A command has been sent to reference the External Mixer in a model that does not contain it
-221	Settings Conflict; FAST method can only be used while Radio Std is W-CDMA	
-221	Settings conflict; Enabled modulation source conflicts with previous modulation source. Previous modulation disabled	Turning one modulation format (like AM, PM, FM or ARB) on when another modulation format is already on results in the previous modulation format being turned off and the generation of an error.
-221	Settings conflict; Feature not available in this View	Some functionality is available in one View, but not in another. (See the Views under the View/Display key.) This error occurs if you send a SCPI command or push a gray-out key that is not available in the current selected View.
-221	Settings conflict; Feature not supported for selected source	You have asked for a feature that the selected source is not capable.
-221	Settings conflict; Feature not supported for this Input.	Some functionality is not available when certain Inputs are selected. For example, Trigger Holdoff is not available for the BBIQ input
-221	Settings conflict; Feature not supported for this measurement.	Some functionality is available in one measurement, but not in another. (See the measurements under the Meas key.) This error occurs if you send a SCPI command or push a gray-out key that is not available in the current selected measurement.
-221	Settings conflict; Feature not supported for this measurement.	Some functionality is available in one measurement, but not in another. (See the measurements under the Meas key.) This error occurs if you send a SCPI command or push a gray-out key that is not available in the current selected measurement.
-221	Settings conflict; Feature not supported for this model number	This functionality is not a part of the instrument you are using but may be found in other models in the X-Series.
-221	Settings conflict; FFT IF Gain High not available when Swept IF Gain = Manual Low	When Swept IF Gain is manually set to Low, you cannot set the FFT IF Gain to High because that would make the Reference Level couplings wrong in FFT mode.
-221	Settings conflict; FFT method is unavailable for level gating	If you are using level gating, you cannot select the FFT Gate Method.

Instrument Messages
Event Messages

Err#	Message	Verbose/Correction Information
-221	Settings conflict; FFT sweep type is not available while in Gated LO	The gated LO function turns the LO on and off as it sweeps. So the FFT sweep type is not available if you have selected gated LO.
-221	Settings conflict; FFT sweep type is not available while in Gated Video	The FFT sweep type is not available if you have selected the gated video function.
-221	Settings conflict; FFT Sweeps unavailable in Tracking Source mode	Since FFT's do not sweep, you cannot use a Tracking Source while doing FFT's
-221	Settings conflict; Fixed Marker Y value is not adjustable with Normalize On	If Normalize is on the Amplitude scale is in dB units, so adjusting the Y value of a Fixed marker is not possible.
-221	Settings conflict; Freq > 3.6 GHz unavailable while electronic attenuator enabled	The electronic attenuator does not function above 3.6 GHz. So if you have that attenuator enabled, you cannot change the center frequency so that frequencies above 3.6 GHz are displayed/measured.
-221	Settings conflict; Function not available in External Mixing	The frequency offset feature cannot be used when you have selected a log scale for the frequency axis.
-221	Settings conflict; Function not available in Tracking Source mode	The feature cannot be used when you are using a Tracking Source.
-221	Settings conflict; Function only available in Tracking Source mode	The feature cannot be used unless you are using a Tracking Source.
-221	Settings conflict; Function unavailable with MW Presel off	You cannot center or adjust the preselector because the Microwave Preselector is currently off
-221	Settings conflict; Frequency Offset not available when Frequency Scale is Log	The frequency offset feature cannot be used when you have selected a log scale for the frequency axis.
-221	Settings conflict; Function unavailable with MW Presel off	You cannot center or adjust the preselector because the Microwave Preselector is currently off
-221	Settings conflict; Gate control is Edge for Gated FFT	You cannot use level triggering to control the gate if you are using the FFT gating method.
-221	Settings conflict; Gate control must be Edge for this Gate Source	You cannot use level triggering to control the gate when you are using the currently selected gate source.

Err#	Message	Verbose/Correction Information
-221	Settings conflict; Gate is not available when Marker Count on	The gate function cannot be used while you have marker count turned on.
-221	Settings conflict; Gate Length is not settable in FFT sweeps	The sweep time for FFT sweeps is set by the calculations. So sweep time settings cannot be adjusted.
-221	Settings conflict; Gate Method is not compatible with current Sweep Type setting	If the Gate is On and you have the FFT Sweep Type manually selected, then the Gate Method cannot be selected.
-221	Settings conflict; Gate not available with external Tracking Source	The Gate functions are unavailable when Source Mode is Tracking with an external source. This is because the Gate circuitry is used to sync the external source.
-221	Settings conflict; Gate not available with Tracking Generator	If the Source Type is Tracking Generator, the Gate circuitry is used for TG sync and is not available for gating
-221	Settings conflict; Gated FFT is not available while Sweep Type is set to Swept	The gated FFT function is not available if you have selected the swept type of sweep. You must be in the FFT sweep type.
-221	Settings conflict; Gated LO is not available while Sweep Type is set to FFT	The FFT sweep type moves the LO frequency in steps. So the gated LO function is not available if you have selected FFT sweep.
-221	Settings conflict; Gated Video is not available while Sweep Type is set to FFT	The gated video function is not available if you have selected the FFT sweep type.
-221	Settings conflict; Incorrect RBW for demod. Change RBW	
-221	Settings conflict; Ind I/Q is not available for this measurement	The Independent I and Q setting is not available for the current measurement. Only some measurements (initially, only VXA) support this setting.
-221	Settings conflict; Invalid trace number	The subopcode used to specify the trace number is invalid for this measurement or query
-221	Settings conflict; Knob is not available to modify this function	You should select a specific value for this function. So scrolling through values with the knob is not allowed.
-221	Settings conflict; LO Phase Noise Adj not available	For instruments without the Dual-Loop LO, this feature is not available
-221	Settings conflict; Log Scale Type is not available with Demod View	The logarithmic x-axis scales are not available when you have the demod view turned on.

Instrument Messages
Event Messages

Err#	Message	Verbose/Correction Information
-221	Settings conflict; Log Scale Type is only available in swept measurement	Logarithmic scaling can be used when making a swept SA measurement. It is not available in the SA measurement when you are using FFT sweeps.
-221	Settings conflict; Marker 1 Trace Update=off turns off Signal Track	Signal Track not available unless the trace containing Marker 1 is updating
-221	Settings conflict; Marker cannot be relative to itself	A marker must be set relative to another marker, not to itself.
-221	Settings conflict; Marker Count is not available when Gate on	The marker count function cannot be used while you have gating turned on.
-221	Settings conflict; Marker Function is not available for a Fixed marker	If a Marker is a Fixed type marker, the marker's value does not change from when it first became fixed. You cannot turn on or change a Marker Function because there is no ongoing measurement data to use for the marker function calculation.
-221	Settings conflict; Marker type must be delta	Mkr Δ ->Span and Mkr Δ ->CF require that the selected marker be a delta marker.
-221	Settings conflict; Marker->function is not available in zero span	Most of the "Marker To" functions are not available if you are in zero span (span = 0 Hz, or time domain). So you cannot send the commands for these functions.
-221	Settings conflict; Mask unavailable for current Span. Increase to display mask.	The current span setting is either narrower than the mask width or so wide that there are too few display points to allow the mask to be drawn. Increase or decrease the span to display the mask.
-221	Settings conflict; Meas Type was changed to Examine for Exp Avg Mode.	Average Mode has been changed to Exponential. Full Meas Type is not available for Exponential Average Mode therefore Meas Type has been changed to Examine.
-221	Settings conflict; Meas Type was changed to Full for Repeat Avg Mode	Average Mode has been changed to Repeat. Examine Meas Type is not available for Repeat Average Mode therefore Meas Type has been changed to Full.
-221	Settings Conflict; MinPts/RBW limit not met	
-221	Settings conflict; Mkr -> CF is not available when the x-axis is time domain	The marker to center frequency functionality does not work when the x-axis is in the time domain.
-221	Settings conflict; Mod Scheme AutoDet unavailable when Burst Sync=RF Amptd	The modulation scheme auto detection is unavailable when the burst sync is set to RF Amptd (GSM/EDGE)

Err#	Message	Verbose/Correction Information
-221	Settings conflict; MS gain is not available in this Mode	Mobile Station gain correction is not available in some Modes, or in some measurements (for example, the SA measurement).
-221	Settings conflict; Must apply Amplitude Correction to make this unit available	These special units only apply when you are doing antenna measurements so you have to have a correction which includes Antenna Units enabled
-221	Settings conflict; No meas frequencies are above 3.6 GHz	Optimize Preselector can only be performed on frequencies in high band i.e. freqs above 3.6 GHz. The current setup does not have input freqs (IF) in this range so an Optimize Preselector cannot be performed.
-221	Settings conflict; no source selected	You must select a source using Select Source before you can do this
-221	Settings conflict; Normal detector is not allowed with X scale is Log	The normal detector cannot be used when the x-axis scale is logarithmic. Why not? Are the results weird? Frequency slewed?
-221	Settings conflict; Normalize is not available when Scale Type = Lin	Normalize does not support Linear amplitude scale, since the results are always presented as a dB ratio.
-221	Settings conflict; Normalize is not available while Demod View is on	The normalization (correction) function cannot be used if you are using the Demod View.
-221	Settings conflict; Normalize is not available while Trace Math is on	The Normalize function works by doing trace manipulation. So if trace math is on you cannot turn on normalization.
-221	Settings conflict; Only active Antenna Unit available; no other Y axis units	When a correction with antenna units is turned on, the only Y-Axis units you can have are those that match the Antenna Unit. Turn off the Correction or the Antenna Unit under Input/Output, Corrections
-221	Settings conflict; Option not available	You have attempted to perform an action for which a required option is not installed
-221	Settings conflict; Param only available when DUT is a freq converter	SCPI only message. The sideband and freq context parameters are only available when a freq conversion setup is in use. Change setup to contain a freq conversion to use these parameters.
-221	Settings conflict; Param only available when External LO Mode is Swept	SCPI only message. This parameter is only available when the LO mode is set to Swept. Change the LO Mode to Swept.
-221	Settings conflict; Param only available when External LO Mode is Fixed	SCPI only message. This parameter is only available when the LO mode is set to Fixed. Change the Freq Mode to Fixed.

Instrument Messages
Event Messages

Err#	Message	Verbose/Correction Information
-221	Settings conflict; Param only available when Frequency Mode is Fixed	SCPI only message. This parameter is only available when the Freq mode is set to Fixed. Change the Freq Mode to Fixed.
-221	Settings conflict; Param only available when Frequency Mode is Swept	SCPI only message. This parameter is only available when the Freq mode is set to Swept. Change the Freq Mode to Swept
-221	Settings conflict; Param only available when valid cal data exists	SCPI only message. The 'Apply Calibration' parameter is only available when the stored cal data matches the current setup. Perform a fresh 'Calibrate Now' or change setup such that current cal data is valid.
-221	Settings conflict; Preamp gain is not available in this Mode	Preamp gain correction is not available in some Modes or Measurements
-221	Settings conflict; Preamp unavailable with electronic attenuator on	The electronic attenuator is on. Internal preamp cannot be used while you are using the electronic attenuator.
-221	Settings conflict; Reference marker must be in same window	A delta marker and its reference must be in the same window. This error occurs when you try to turn on a delta marker who's reference is in a different window.
-221	Settings conflict; Relative Trigger needs hardware support for this meas	To do Relative Triggering in this measurement requires optional hardware that is not present in this analyzer.
-221	Settings conflict; Scale Type = Lin is not available when Normalize is on	Only the Log amplitude scale is available in Normalize, since the results are always presented as a dB ratio.
-221	Settings conflict; Sequence may have gaps when playing step <n>, if next step trigger comes later than current step expires	You set step duration type of step n to Time or Play Count while the Step Trigger of step n+1 is not set to "Free Run". So if next step trigger comes later than the expiration of the current step play time, the ARB will stop playing and cause a gap between steps. This is a warning.
-221	Settings conflict; Pre-trigger is insufficient for demod. Decrease Trig Delay.	
-221	Settings conflict; Signal Track is not available with Continuous Peak	The signal tracking feature cannot be used while you are also using the continuous peak function.
-221	Settings conflict; Signal Track is only available in Swept SA measurement	The signal track functionality can be used when making a swept SA measurement. It is not available in the SA measurement when you are using FFT sweeps.

Err#	Message	Verbose/Correction Information
-221	Settings conflict; Signal Track is turned off when Zero Span is selected	Signal Track is not available when you have selected Zero Span. So if Zero Span is entered while in Signal Track is On, Signal Track is turned off.
-221	Settings Conflict; Span limited to XXX	
-221	Settings conflict; Span Zoom is not available in Zero Span	Span Zoom does not work with a time domain x-axis. You must select a span greater than 0 Hz.
-221	Settings conflict; Span Zoom not available when Frequency Scale Type = Log	The Span Zoom feature cannot be used when the X-axis scale is logarithmic frequency.
-221	Settings conflict; Step duration cannot be set to Play Count when the step is generating a CW tone	You tried to set the source list step duration type to Play Count while the waveform of the step is CW. Play Count only applies to ARB.
-221	Settings conflict; Step keys are not available to modify this function	You should select a specific value for this function. So using the Up/Down step keys to scroll through values is not allowed.
-221	Settings conflict; Sweep Setup only available in swept measurements	The current measurement uses FFT mode and so does not use the Sweep Setup menu
-221	Settings conflict; Sweep Time cannot be auto-coupled in FFT sweeps	The sweep time for FFT sweeps is set by the calculations. So sweep time settings cannot be adjusted.
-221	Settings conflict; Sweep Time cannot be auto-coupled while in Zero Span	You cannot send the remote command to set the sweep time to auto while you are in zero span.
-221	Settings conflict; Sweep Time cannot be set while in FFT sweeps	The sweep time for FFT sweeps is set by the calculations. It cannot be manually controlled.
-221	Settings conflict; Swept IF Gain High not available when FFT IF Gain = Manual Low	When FFT IF Gain is manually set to Low, you cannot set the Swept IF Gain to High because that would make the Reference Level couplings wrong in swept mode.
-221	Settings conflict; Swept LO not available when freq mode is Fixed	SCPI only message. The LO Mode cannot be set to Swept when the freq mode is set to fixed. Change the freq mode away from fixed or perform the measurement at several fixed frequencies.
-221	Settings conflict; Swept Type=Swept is not available while in Gated FFT	If you have selected gated FFT then you are using the FFT sweep type and you cannot select the swept type of sweeping.

Instrument Messages
Event Messages

Err#	Message	Verbose/Correction Information
-221	Settings conflict; System Display Settings, Annotation is Off	This is an override that turns off many of the annotations. This is available as a security feature.
-221	Settings conflict; T hot must be greater than T cold	The T cold value set under Meas Setup/ENR/Tcold, needs to be lower than the T hot value currently being set. T cold is often taken as the ambient temperature of the noise source. If using an SNS the T cold value may be read automatically before every sweep.
-221	Settings Conflict; The parameter cannot be changed in FAST mode	
-221	Settings conflict; The number of input parameters is too large and is truncated to current list step number	An attempt to set list sequence parameter whose index exceeds the "Number of Steps". This way only those parameters whose indexes fall in number of steps will be accepted. Reduce the number of parameters to be no large than "Number of Steps".
-221	Settings conflict; Trace Math is not available while Normalize is on	The Normalize function works by doing trace manipulation, so trace math is not available while normalization is running.
-221	Settings conflict; Tracking Source unavailable in FFT Sweeps	Since FFT's do not sweep, you cannot use a Tracking Source while doing FFT's
-221	Settings conflict; Trigger input in use for source synchronization	If Point Trigger is being used with an external trigger input to synchronize an external source to the analyzer, that trigger input is unavailable for triggering.
-221	Settings conflict; Trigger is not available with span > 0 Hz.	
-221	Settings conflict; Tx Band Spur meas does not support this frequency band.	The transmit band spur measurement does not support all of the commercially available frequency bands. You need to change your selection under Mode Setup, Radio, Band to one of the supported bands.
-221	Settings conflict; Tx Band Spur measurement is not defined for mobiles.	Only base station testing is available.
-221	Settings conflict; Zero Span not available when Frequency Scale Type = Log	Logarithmic scales cannot be used for time domain sweeps (0 Hz span).
-221	Settings conflict; Administrator privileges required	You must be logged in with administrator privileges to do this. Log out and log back in as the administrator, then restart the SA application.

Err#	Message	Verbose/Correction Information
-221	Settings conflict; Auto Scan Time/Meas Time do not apply in Stepped Scan Type.	The Auto Scan Time/Meas Time are not available when Scan Type =Stepped Scan.
-221	Settings conflict; ClearList & Start not available when ScanSeq = (Re)measure	Cannot perform Clear List & Start during (Re)measure because we need the frequency information of the peaks in signal list to perform (Re)measure.
-221	Settings conflict; EMI Detectors and Average detector can't be used together	User is not allowed to turn on any EMI Detector and Average detector together. They are always mutually exclusive.
-221	Settings conflict; Freq > 1 GHz is not available while RF Input 2 enabled	Frequency is limited to 1 GHz while RF Input 2 is enabled.
-221	Settings conflict; Function not available while measurement is running	Settings change is not allowed while measurement is running. You must stop the current measurement if you wish to change the settings.
-221	Settings conflict;function unavailable with this EMC Standard	
-221	Settings conflict; Include Source is Yes. ARB memory operation is rejected	You tried to load or delete files to/from ARB memory in the Sequence Analyzer mode when Include Source is set to Yes. First set Include Source to No, then perform desired ARB memory operation.
-221	Settings conflict; Log Percent Auto Step Rule does not apply in Swept Scan Type.	The Log Percent rule is not available when Scan Type=Swept Scan because we are always doing linear sweep.
-221	Settings conflict; MPA TX port<n> amplitude correction delta exceeds <n>dB between port<n1> and port<n2>	Indicating the amplitude correction delta value between MPA TX port<n1> and port<n2> for MXG mode (port difference) exceeds max loss delta value. Set related amplitude correction delta value to be lower than the max loss delta value given in error message.
-221	Settings conflict; MPA TX port<n> amplitude correction value <n>dB is out of range. The valid range is <n> ~ <n>dB	Indicating the amplitude correction value of MPA TX port<n> for MXG mode is out of range. Set related amplitude correction value within the valid range given in error message.

Instrument Messages
Event Messages

Err#	Message	Verbose/Correction Information
-221	Settings conflict; MPA TX port<n> power setting <n>dBm is lower than -130dBm minimum	Indicating the power output setting (UI power + Amp Corr Value) on MPA TX port<n> is lower than supportable minimum -130dBm. Set power output setting to be larger than -130dBm to eliminate this warning.
-221	Settings conflict; MPA GPS port power setting <n>dBm is lower than -130dBm minimum	Indicating the power output setting (UI power + Amp Corr Value) on MPA GPS port is lower than supportable minimum -130dBm. Set power output setting to be larger than -130dBm to eliminate this warning.
-221	Settings conflict; Source List Step<n> MPA TX port<n> power setting <n>dBm is lower than -130dBm minimum	Indicating the power output setting (UI power + Amp Corr Value) on MPA TX port<n> on Source List Step<n> is lower than supportable minimum -130dBm. Set power output setting to be larger than -130dBm to eliminate this warning.
-221	Settings conflict; Source List Step<n> MPA GPS port power setting <n>dBm is lower than -130dBm minimum	Indicating the power output setting (UI power + Amp Corr Value) on MPA GPS port on Source List Step<n> is lower than supportable minimum -130dBm. Set power output setting to be larger than -130dBm to eliminate this warning.
-221	Settings conflict; QPD + EMI Average + RMS Average is not allowed	User is not allowed to turn on all 3 EMI detectors together. You must turn off one of the EMI Detectors before you turn this on.
-221	Settings conflict; Range <{0}> is turned off as total range points > 40001	Max of Total range points is 400000. Reduce Scan Points or increase Step Size in order to turn on that range.
-221	Settings conflict; RF Input 2 is not available above 1 GHz	If the frequency range is set above 1 GHz, user is not allowed to change to RF Input 2.
-221	Settings conflict; Scan Time & Points do not apply in current Step/Time Control.	The Scan Time & Points are not available when Step/Time Control is set to Step & Dwell.
-221	Setting conflict; Sequence too long, Acq = #	The duration of the whole sequence is too long. With current configurations, The Sequence can only handle #-1 Acquisitions.
-221	Settings conflict; Source List Step<n> MPA TX port<n> amplitude correction delta exceeds <n>dB between port<n1> and port<n2>	Indicating the amplitude correction delta value between MPA TX port<n1> and port<n2> on Source List Step<n> (port difference) exceeds max loss delta value. Set related amplitude correction delta value to be lower than the max loss delta value given in error message.

Err#	Message	Verbose/Correction Information
-221	Settings conflict; Source List Step<n> MPA TX port<n> amplitude correction value <n>dB is out of range. The valid range is <n> ~ <n>dB	Indicating the amplitude correction value of MPA TX port<n> on Source List Step<n> is out of range. Set related amplitude correction value within the valid range given in error message.
-221	Settings conflict; Step Size & Meas Time do not apply in current Step/Time Control.	The Step Size & Meas Time are not available when Step/Time Control is set to Scan Time&Pts.

-200 to -299, Execution Errors

For -221 error messages, see the previous sections.

Note that Execution Errors are divided into subclasses:

- 21x – Trigger errors
- 22x – Parameter error
- 23x – Data corrupt or stale (invalid data)
- 24x – Hardware error
- 25x – Mass storage error
- 26x – Expression data error
- 27x – Macro error
- 28x – Program error (a downloaded program-related execution error)
- 29x – Memory use error

Err#	Message	Verbose/Correction Information
-200	All ranges are off. Turn on at least a range	There are no range turn on in scan table. You need to turn on at least a range to initiate a scan.
-200	At Full Zoom	Marker Zoom is not available as it has reached full zoom.
-200	At Full Zoom	Marker Zoom is not available as it has reached full zoom.
-200	Execution Error	A program execution error has occurred. The exact problem cannot be specifically identified.
-200	Execution error; Carrier frequency outside device's transmit band	The entered channel/carrier frequency is not within the range of your current mode setup selection of standard and device.
-200	Execution error; Invalid GSM burst timing	A GSM-like burst was acquired, but its timing is not valid. Ensure the correct Burst Type has been selected.

Instrument Messages
Event Messages

Err#	Message	Verbose/Correction Information
-200	Execution error; Invalid IP address	The IP address supplied is either not valid or does not belong to a compatible Signal Generator. Please check the IP address and instrument connection and try again.
-200	Execution error; Invalid Marker Trace.	Cannot place markers on the reference trace, because the reference trace is currently turned off or has no data.
-200	Execution Error; No peak found.	No signal peak was found within the defined parameters of the search. (Note: for ESA/PSA compatibility, the Swept SA measurement uses 780 for this error number; all other measurements use -220)
-200	Execution error; No ranges are defined. Activate a range.	There are no active ranges in the range table. You will need to activate at least one range.
-200	Execution Error; Preselector centering failed	Algorithm failed to center the preselector. This maybe caused by the signal peak being too low in amplitude. Or it could be from excessive CW input signal, alignment error, or hardware failure.
-200	Execution Error; Signal not stable enough to track	The signal that you have selected to track is changing too much for the function to track it properly.
-200	Execution Error; Store ref trace before turning on Normalize	The Reference trace data must be stored in the Ref trace before you turn on the Normalization function.
-200	Execution error; Sync word was not found.	NADC & PDC: In an EVM measurement, the sync word is not found and the synchronization cannot be established when Sync Word is selected in the Burst Sync menu. Flexible Digital Demodulation: The sync word cannot be detected because of inappropriate parameter settings or incorrect signal.
-200	Execution error; Trace file contains no compatible traces.	The trace file may have been created by another version of the Phase Noise personality, which uses a different trace format that is incompatible with the version you are running. Please check you are running the most up to date version of the personality.
-200	Execution error; Trace file created by incompatible version of Phase Noise App	The trace file may have been created by another version of the Phase Noise personality, which uses a different trace format that is incompatible with the version you are running. Please check you are running the most up to date version of the personality.
-200	Function not available before Marker Zoom is performed	Function not available before perform Marker Zoom

Err#	Message	Verbose/Correction Information
-200	Must perform Scan before do Search	Cannot perform Search as the trace data is found empty
-200	No marked signal	Cannot perform the selected function because no signal was marked. You must mark the peak of interest before selecting the function.
-200	No Measure At Marker Added to Signal List	No signal peak was added into Signal List as there is no valid measure to Marker result. You must perform Measure at maker before selecting Measure At Marker --> List.
-200	No Peak Added to Signal List	No signal peak was added from the Search to Signal List as there is no signal peaks found within the defined parameters of the search criteria.
-200	Signal List is Empty	Cannot perform the selected function because the signal list contains no data.
-200	Signal List is Full	Cannot perform the selected function because the signal list is full. Please clear the list.
-200	Signal Selected is not in the Signal List	The signal selected is not the list. You only can perform the operation on signal that is already available in the list.
-201	Invalid while in local	The command cannot be executed while the instrument in Local control.
-202	Settings lost due to rtl	A "return to local" control was forced and some settings were lost as a result of this.
-203	Command protected	The command could not be executed because it is disabled. It was disabled by licensing or password protection
-203	Command protected; feature not licensed	The specified feature, for example "N9073A-TR2" is not licensed. The license may have expired. You cannot use it until you get a license.
-203	Command protected; Feature Not Supported. No appropriate waveform license installed for <filename>	An attempt was made to select a waveform while the required license is not installed. Install the necessary Signal Studio waveform licenses or multi-pack licenses.
-210	Trigger error	A trigger error has occurred, but the exact problem cannot be specifically identified.
-211	Trigger ignored	A GET, *TRG or other triggering signal was received, but it was ignored because of timing considerations. For example, maybe the instrument was not ready to respond when the command was received.
-212	Arm ignored	An arming signal was received, but it was ignored.
-213	Init ignored	An initiate trigger/sweep request was received and ignored, because another measurement was already in progress.

Instrument Messages
Event Messages

Err#	Message	Verbose/Correction Information
-214	Trigger deadlock	The trigger source for the initiation of a measurement is set to GET, and the following measurement query was received. The measurement cannot be started until a GET is received, but the GET would cause an INTERRUPTED error.
-215	Arm deadlock	The arm source for the initiation of a measurement is set to GET and the following measurement query is received. The measurement cannot be started until a GET is received and the GET would cause an INTERRUPTED error.
-220	Parameter error	A problem was found with a program data element. The exact problem cannot be specifically identified.
-220	Parameter error; <filename> is not loaded into ARB memory. Load the file before assigning to a multi-pack	An attempt was made to assign a multi-pack license to a waveform, while the waveform file has not been loaded into ARB memory . Load ARB into ARB memory first then add the ARB in multi-pack license slot.
-220	Parameter error;<filename> does not have a unique id, therefore cannot be assigned to a multi-pack	An attempt was made to add a Signal Studio waveform to a license slot while the waveform unique id is zero. Set the waveform unique ID to a value other than zero.
-220	Parameter error;Cannot create directory to save waveform sequence file. <error info>	An attempt was made to create a directory to store new waveform sequence but failed Input correct directory path parameter.
-220	Parameter error;Cannot find the first waveform file <filename>	An attempt was made to build a new waveform sequence while the first specified waveform file is not found. Specify correct path for the first waveform segment.
-220	Parameter error;Invalid waveform sequence file path	An attempt was made to build or query a waveform sequence while the waveform sequence file path is invalid or not specified. Specify a correct path for the waveform sequence.
-220	Parameter error;License slot <n> is already locked	An attempted was made to lock a slot while the slot was already locked.
-220	Parameter error;License slot <n> is illegal, slot number must be positive	An attempt was made to input a slot number less than or equal to 0. Waveform slot number must be positive.
-220	Parameter error;License slot <n> is locked and cannot be cleared	An attempt was made to clear a slot while the slot was already locked.

Err#	Message	Verbose/Correction Information
-220	Parameter error;License slot <n> is locked, therefore cannot be replaced	An attempt was made to replace a slot with another waveform while the slot was already locked.
-220	Parameter error;License slot <n> is not assigned, therefore cannot be locked	An attempt was made to lock a slot while the slot was not assigned.
-220	Parameter error;Nested sequence file is not supported	An attempt was made to add a sequence file as a waveform segment into another sequence file
-220	Parameter error;Nested sequence file is not supported	An attempt was made to build a new waveform sequence which contains another waveform sequence file. Do not nest waveform sequence file (*.seq) into another waveform sequence file (*.seq).
-220	Parameter error;No. <n> waveform file path is invalid	An attempt was made to build a new waveform sequence while the nth waveform file path is invalid or not specified. Specify a correct path for the waveform.
-220	Parameter error;Repetition value must be within 1 and 65535	An attempt was made to build a new waveform sequence with the repetition value set to less than 1 or greater than 65535.
-220	Parameter error;Sequence will be stuck on step <step number>. Next step trigger cannot be free run when current step duration is continuous	An attempt was made to set the current step duration to continuous, while the step trigger of the next step is set to free run Make the next step trigger to be other than free run.
-220	Parameter error;Suffix of waveform sequence file should be ".seq"	An attempt was made to build a new waveform sequence while the suffix of waveform sequence file is not ".seq". Ensure that the waveform file suffix and file format is consistent with "seq".
-220	Parameter error;Transition time is longer than duration time on step<step number>	An attempt was made to set the source step transition time to a value that is longer than step duration time, when the step duration type is "Time" Make the transition time shorter than the duration time.
-220	Parameter error;Unrecognized marker type: <marker>	An attempt was made to build a new waveform sequence while the marker type value is invalid. Input correct maker type parameter.

Instrument Messages
Event Messages

Err#	Message	Verbose/Correction Information
-220	Parameter error;Waveform <filename> is already assigned to a waveform slot	An attempt was made to assign a waveform to a slot while the waveform was already assigned to another waveform slot.
-220	Parameter error;Waveform cannot be multi-pack licensed, no multi-pack slots available	An attempt was made to multi-pack license a waveform, but there are no free multi-pack license slots. Install multi-pack licenses to get multi-pack license slots.
-220	Parameter error;Waveform of that ID is already multi-pack licensed	An attempt was made to multi-pack license a waveform that was already licensed by a different multi-pack license slot.
-221	Settings conflict;	There are many types of settings conflict errors. See section 3.5 for information about these errors.
-222	Data out of range;	A data element was found but the instrument could not be set to that value because it was outside the range defined for the command. A descriptive message may be appended, such as "clipped to upper limit"
-222	Data out of Range; clipped to source max/min	A source parameter has been entered that exceeds the range of the selected source. The parameter has been clipped to match the range of the source
-222	Data out of range; Invalid list data	You tried to use a trace that has a number of sweep points that is different from the current setting of sweep points.
-222	Data out of range; Two entries already exist at this x-axis value.	When entering values for limit lines, you cannot have more than two y-axis (amplitude) values entered for a specific x-axis (frequency) value.
-223	Too much data	A data element (of block, expression, array type, or string type) had more data than allowed by the command, or by the available memory.
-223	Too much data; 200 spurs found. Additional spurs ignored.	There are too many spurs for the table (the limit is 200), and any additional spurs that are found will be ignored.
-224	Illegal parameter value	An exact data value (from a list of the allowed values) was required - but not found. See the feature description for information about the expected parameter values.
-224	Illegal parameter value; <Value> invalid. Fractional values are not allowed.	The seconds parameter of an LXI time may not contain a fractional portion. For example 123456789.0 is valid while 123456789.1 is not.
-224	Illegal parameter value; <value> out of range.	The value does not fall in the valid range

Err#	Message	Verbose/Correction Information
-224	Illegal parameter value; Cannot set waveform to continue previous waveform when previous step is set to CW or Off	An attempt was made to set the step duration for a step in a sequence to “Continue Previous”, but the previous step was outputting a CW tone or is Off, so there is no waveform to continue.
-224	Illegal parameter value; Cannot set waveform to continue previous waveform on the first step	An attempt was made to set the waveform for the first step in a sequence to “Continue Previous” while there is no previous waveform to continue playing back.
-224	Illegal parameter value; Channel number is invalid for current band/link combination	An attempt was made to enter a channel number for a step within the List Sequencer, but the channel number is out of the valid range for the Band and Radio Band Link direction combination defined within the step.
-224	Illegal parameter value; Exceeding the max list length	The list parameters have a maximum allowed length. You are trying to set a length longer than the maximum.
-224	Illegal parameter value; Gated FFT is not available while Sweep Type is set to Swept	The gated FFT function is not available if you have selected the swept type of sweep. You must be in the FFT sweep type.
-224	Illegal parameter value; Gated LO is not available while Sweep Type is set to FFT	The FFT sweep type moves the LO frequency in steps. So the gated LO function is not available if you have selected FFT sweep.
-224	Illegal parameter value; Gated Video is not available while Sweep Type is set to FFT	The gated video function is not available if you have selected the FFT sweep type.
-224	Illegal parameter value; Illegal identifier <identifier>. This value may already be in use.	The value for the LXI LAN identifier parameter must be unique (i.e. LAN0 and LAN7 must have different identifier strings).
-224	Illegal parameter value; Index out of range	When querying the LXI Event Log or the Servo Log, an index may be used to look at a specific entry. This error occurs if the index provided does not point to a valid entry.
-224	Illegal parameter value; Invalid list length	You are trying to set some list measurement settings, but the multiple lists that you sent were not all the same length. The number of settings must be consistent from list to list.
-224	Illegal parameter value; LXI Event <event> already exists.	This error occurs when you try to add an LXI Event that has already been added.

Instrument Messages
Event Messages

Err#	Message	Verbose/Correction Information
-224	Illegal parameter value; LXI Event <event> contains illegal characters.	When a new LXI Event is created, it may not use the comma, semicolon, or newline characters. All other printable ASCII characters are valid.
-224	Illegal parameter value; LXI Event <event> does not exist.	The requested event has not been added yet.
-224	Illegal parameter value; Measurement not available	You tried to turn on a measurement that is not available in the current mode.
-224	Illegal parameter value; This instrument is always DC coupled	You can't set AC coupling in this instrument
-224	Illegal parameter value; This model is always AC coupled	You can't set DC coupling in this analyzer
-225	Out of memory	There is not enough memory to perform the requested operation.
-225	Out of memory; Insufficient resources to load Mode <mode name>	If you attempt to load a mode via SCPI that will exceed memory capacity, the Mode does not load and this message is returned. "mode name" is the SCPI parameter for the Mode in question, for example, SA for Spectrum Analyzer Mode. You can free up resources in the System, Power On, Configure Applications menu
-225	Out of memory; Memory limit caused Data Acquisition to be truncated	
-226	List not same length	You are using the LIST structure, but have individual lists that are not the same lengths.
-230	Data corrupt or stale;	A legal data element was found, but it could not be used because the data format or the data structure was not correct. Maybe a new measurement had been started but had not completed.
-230	Data corrupt or stale; Measurement data is not available	Measurement data not available. The measurement that you are trying to get data from must be the current active measurement. Maybe you have not initiated the measurement, or it has not completed all the sweeps/averages needed.
-230	Data corrupt or stale; Trace contains no data.	Trace cannot be displayed because currently there is no data assigned to it. Use the functions under the Trace menu, or load a previously saved trace, to assign data to the trace.

Err#	Message	Verbose/Correction Information
-230	Data corrupt or stale; Unable to load state from file	There is something wrong with the state data in the desired file. Maybe the file is corrupt, or it is from an instrument/version that is not recognized by the current instrument.
-231	Data questionable	Indicates that the measurement accuracy is suspect
-232	Invalid format	A data element was found but it could not be used because the data format or the data structure was not correct.
-232	Invalid format; Map information not loaded	Instrument failed to load the burst mapping information from the selected file.
-232	Invalid format;<filename> contains invalid waveform header and cannot be loaded into ARB memory	An attempt was made to load, into ARB memory, a Signal Studio waveform file that contains an invalid waveform header into ARB memory.
-232	Invalid format;<filename> has less than 500 IQ samples	An attempt was made to load, into ARB memory, a waveform file, but the file does not contain enough IQ samples. Load an ARB waveform with a sample number equal to or greater than 500.
-232	Invalid format;Syntax error on source step <step number>	An attempt was made to load in a list sequencer file that was incorrectly formatted.
-232	Invalid format;Unable to open encrypted waveform file <filename>	An attempt was made to load, into ARB memory, a Signal Studio waveform file, but cannot be opened due to invalid file format.
-233	Invalid version	A legal data element was found but could not be used because the version of the data is incorrect. For example, state data changes as new instrument features are added, so old state files may not work in an instrument with a newer version of software.
-240	Hardware error	A legal program command or query could not be executed because of a hardware error. The exact problem cannot be specifically identified.
-240	Hardware error; See details in Windows Event Log under SA	The internal data acquisition system detected a problem at startup and logged the details in the Windows Event Log.
-241	Hardware missing	The operation could not be performed because of missing hardware; perhaps the optional hardware is not installed.
-241	Hardware missing; Input not available	The hardware required is not part of this model or the option is not installed

Instrument Messages
Event Messages

Err#	Message	Verbose/Correction Information
-241	Hardware missing; Internal preamp not available at all frequency points	The Internal Preamp is currently turned on, but the measurement is being performed completely or partially outside the range of the preamp. It is recommended that the user turns preamp off to ensure consistent results across the entire measurement.
-241	Hardware missing; not available for this model number	The hardware required is not part of this model
-241	Hardware missing; Option not installed	The optional hardware is not installed.
-241	Hardware missing; not available for this model number	The hardware required is not part of this model.
-250	Mass storage error;	A problem was found with the mass storage device (memory, disk drive, etc.). The exact problem cannot be specifically identified.
-250	Mass storage error; Access denied	Access is denied.
-250	Mass storage error; Bad path name	The specified path is invalid.
-250	Mass storage error; Can only import single trace .csv files	Trace files containing multiple traces cannot be imported. However, if you need to recall multiple traces you can use the Save and Recall functions rather than the Import and Export functions.
-250	Mass storage error; Can only load an Antenna Unit into Correction 1	The only Correction register that supports Antenna Units is number 1. You have attempted to load an Ampcor file which contains antenna units into another register
-250	Mass storage error; Cannot make	The directory or file cannot be created.
-250	Mass storage error; Different Antenna Unit already in use	Attempt to import Corrections file with Antenna Unit that differs from an in-use correction.
-250	Mass storage error; Directory not found	The system cannot find the path specified.
-250	Mass storage error; Failed to Load trace. Bad file format.	The load trace operation could not be completed, as the input file was not in the expected format. You can only load traces that were previously saved using the 'Save Trace' feature.
-250	Mass storage error; File <filename> wrong type	Attempt to import a data file that is not the proper type for this operation.

Err#	Message	Verbose/Correction Information
-250	Mass storage error; File <filename> and instrument version mismatch	While opening a file, there was a mismatch between file version or model number with instrument version or model number. The import still tried to load as much as possible, but you should check it closely.
-250	Mass storage error; File contains incorrect data for this operation	There is a mismatch between the file data type of the file specified and the destination indicated. For example, a correction set cannot be loaded/imported into a limit line.
-250	Mass storage error; File empty	Cannot save trace because it contains no data. Check that the trace is turned on and contains some valid data.
-250	Mass storage error; Invalid register number for *SAV or *RCL Mass Storage error	You have used the *SAV command to save a state to a nonexistent state register. Or You have used the *RCL command to recall a state register that wasn't previously saved with the *SAV command.
-250	Mass storage error; Lock violation	The process cannot access the file because another process has locked a portion of the file.
-250	Mass storage error; Mkr Table must be on to save Mkr Table as Meas Results	You have to have a Marker Table on the screen before you can save it. Turn on the Marker Table and try again.
-250	Mass storage error; No file names available	Attempt to use the auto file name generation when all 10,000 file names are taken.
-250	Mass storage error; Open failed	The system cannot open the device or file specified. This could be because the storage media is full, or possibly due to a filename error. If using an external storage device, check that the device is properly formatted.
-250	Mass storage error; Pk Table must be on to save Pk Table as Meas Results	You have to have a Peak Table on the screen before you can save it. Turn on the Peak Table and try again.
-250	Mass storage error; Read fault	The system cannot read from the specified device.
-250	Mass storage error; Register <number> empty	Attempt to recall a register with nothing in it
-250	Mass storage error; Sharing violation	The process cannot access the file because it is being used by another process.
-250	Mass storage error; Spectrogram must be on to save as Meas Results	You have to have a Spectrogram on the screen before you can save it. Turn on the Spectrogram and try again.
-250	Mass storage error; Too many open files	The system cannot open the file.

Instrument Messages
Event Messages

Err#	Message	Verbose/Correction Information
-250	Mass storage error; Write fault	The system cannot write to the specified device.
-250	Mass storage error;<directory> does not exist	An attempt was made to load all file from a directory while the specified directory does not exist on the instrument hard disk. Create the specified directory and then load the files or load the files using an existing directory.
-250	Mass storage error;<filename> cannot be deleted as it is currently in use	With ARB ON, an attempt was made to delete a waveform that was being played. Turn ARB to Off first, then delete ARB file from ARB memory.
-250	Mass storage error;<filename> cannot be deleted as it is used in sequencer	With the list sequencer state ON, an attempt was made to delete a waveform that was being used by the sequencer. First turn the List Sequencer to Off, then delete ARB file from ARB memory.
-250	Mass storage error;<filename> used by sequencer is not in the ARB memory, cannot start sequencer	An attempt was made to start the sequencer without loading all of the needed waveform files into ARB memory. First load all necessary ARB files into ARB memory, then initiate the list sequence.
-250	Mass storage error;Create Directory Error: <directory> <err info>	An attempt was made to create a directory on the hard drive and failed.
-250	Mass storage error;Delete File Error: <filename> <err info>	An attempt was made to save data to an existing file and an error occurred deleting the old file.
-250	Mass storage error;Write File Error: <filename> <err info>	An attempt was made to save data to a file and an error occurred in writing the file.
-252	Missing media	A legal command or query could not be executed because missing media.
-253	Corrupt media	A removable media was found to be bad or incorrectly formatted. Any existing data on the media may have been lost.
-254	Media full	A legal command/query could not be executed because the media was full
-254	Media Full;<filename> cannot be loaded to ARB memory	The request to load a file to ARB memory failed because the ARB memory is full. OR An attempt was made to load a set of waveforms and there was insufficient free ARB memory to load all of the waveforms.

Err#	Message	Verbose/Correction Information
-255	Directory full	A legal command or query could not be executed because media directory was full.
-256	File name not found:<file name>	A waveform file was specified and was not found. OR A specified file is not at the specified location.
-256	File name not found;	A legal command or query could not be executed because the file name was not found in the specified location.
-257	File name error;	A legal command or query could not be executed because there was an error with the file name on the device media. For example, maybe you tried to copy to a duplicate file name.
-257	File name error; Allowable extension is .csv	You are using the wrong type of file extension for the current data/file type.
-257	File name error; Allowable extension is .png	You are using the wrong type of file extension for the current data/file type.
-257	File name error; Allowable extension is .state	You are using the wrong type of file extension for the current data/file type.
-257	File name error; Invalid file name	The filename, directory name, or volume label syntax is incorrect.
-257	File name error; name too long	
-257	File name error; <filename> contains unrecognized file suffix	An attempt was made to load or save a file with a suffix other than "bin", "waveform", "wfm" or "seq". Ensure that the waveform file suffix and file format are consistent with "bin", "waveform", "wfm" or "seq".
-257	File name error; Waveform file not selected	An attempted was made to turn the ARB player ON but a file has not been selected for playback. Select a waveform first, and then turn on ARB state.
-258	Media protected	A legal command or query could not be executed because the media was protected. For example, the write-protect was set
-260	Expression error	An error was found with an expression type of data element. The exact problem cannot be specifically identified.
-261	Math error in expression	An expression that has legal syntax could not be executed because of a math error. For example, maybe you are dividing by zero.
-270	Macro error	Indicates that a macro-related execution error occurred.

Instrument Messages
Event Messages

Err#	Message	Verbose/Correction Information
-271	Macro syntax error	Indicates a syntax error within the macro definition
-272	Macro execution error	Indicates that a syntactically legal macro program data sequence could not be executed due to some error in the macro definition
-273	Illegal macro label	Indicates that the macro label defined in the *DMC command was a legal string syntax, but could not be accepted
-274	Macro parameter error	Indicates that the macro definition improperly used a macro parameter placeholder
-275	Macro definition too long	Indicates that a syntactically legal macro program data sequence could not be executed because the string or block contents were too long for the device to handle
-276	Macro recursion error	Indicates that a syntactically legal macro program data sequence could not be executed because the device found it to be recursive
-277	Macro redefinition\ not allowed	Indicates that a syntactically legal macro label in the *DMC command could not be executed because the macro label was already defined
-278	Macro header not found	Indicates that a syntactically legal macro label in the *GMC? query could not be executed because the header was not previously defined.
-280	Program error	There was an execution error in a down-loaded program. The exact problem cannot be specifically identified.
-281	Cannot create program	Indicates that an attempt to create a program was unsuccessful. A reason for the failure might include not enough memory.
-282	Illegal program name	The name used to reference a program was invalid; for example, redefining an existing program, deleting a nonexistent program, or in general, referencing a nonexistent program.
-283	Illegal variable name	An attempt was made to reference a nonexistent variable in a program.
-284	Program currently running	Certain operations dealing with programs may be illegal while the program is running; for example, deleting a running program might not be possible.
-285	Program syntax error	Indicates that a syntax error appears in a downloaded program. The syntax used when parsing the downloaded program is device-specific.
-286	Program runtime error	
-290	Memory use errors	
-291	Out of memory	

Err#	Message	Verbose/Correction Information
-292	Referenced name does not exist	
-292	Reference name does not exist; Waveform sequence contains an invalid waveform <filename>	<p>A waveform sequence was selected for playback but not all of the waveform segments in the waveform sequence are loaded into ARB memory.</p> <p>Ensure that all of the waveform segments are loaded into the ARB memory.</p>
-293	Referenced name already exists	
-294	Incompatible type	Indicates that the type or structure of a memory item is inadequate

-100 to -199, Command Errors

Err#	Message	Verbose/Correction Information
-100	Command error	There is a problem with the command. The exact problem cannot be specifically identified.
-101	Invalid character	An invalid character was found in part of the command.
-102	Syntax error	An unrecognized command or data type was found, for example a string was received for a command that doesn't accept strings.
-103	Invalid separator	The command was supposed to contain a separator but we found an illegal character. For example, the semicolon was omitted after a command string.
-104	Data type error	We found a data type different than what was expected. For example, numeric or string data was expected, but block data was found.
-105	GET not allowed	A Group Execute Trigger was received within a program message.
-108	Parameter not allowed	More parameters were received than were expected for the command. For example, the *ESE common command only accepts one parameter, so sending *ESE 0,1 is not allowed.
-109	Missing parameter	Fewer parameters were received than required for this command.
-110	Command header error	This is a general error that is generated when a problem is found in a command header, but we can't tell more specifically what the problem is
-111	Header separator error	We found an illegal character in a command where we expected to find a separator.
-112	Program mnemonic too long	The command contains a keyword that is more than twelve characters.
-113	Undefined header	The command meets the SCPI syntax requirements, but is not valid in the current measurement environment.
-114	Header suffix out of range	The value of a numeric suffix that is attached to a program mnemonic makes the header invalid. (A suffix is usually units, like Hz or DB.)
-115	Unexpected number of parameters	The number of parameters received does not correspond to the number of parameters expected.
-120	Numeric data error	An error was found in a data element that appears to be numeric. The exact problem cannot be specifically identified.
-121	Invalid character in number	A character was found that is not valid for the data type. For example, an alpha in a decimal numeric or a "9" in octal data.

Err#	Message	Verbose/Correction Information
-123	Exponent too large	The magnitude of an exponent was greater than 32000.
-124	Too many digits	The mantissa of a decimal-numeric contained more than 255 digits, excluding leading zeros.
-128	Numeric data not allowed	A legal numeric data element was found, but that is not a valid element at this position in the command.
-130	Suffix error	A problem was found in a suffix (units). The exact problem cannot be specifically identified.
-131	Invalid suffix	There is a syntax problem with the suffix. You need to use the suffix (units) that are allowed by this command.
-134	Suffix too long	The suffix contained more than twelve characters.
-138	Suffix not allowed	A suffix was found after a numeric element that does not allow suffixes (units).
-140	Character data error	A problem was found with a character data element. The exact problem cannot be specifically identified.
-141	Invalid character data	Either the character data element contains an invalid character or the element itself is not valid for this command.
-144	Character data too long	The character data element contains more than twelve characters.
-148	Character data not allowed	A character data element that you sent is valid, but it is not allowed in this point in the parsing.
-150	String data error	A problem was found with a string data element. The exact problem cannot be specifically identified.
-151	Invalid string data	A string type of data element was expected, but it is invalid for some reason. For example, an END message was received before the terminal quote character.
-158	String data not allowed	A string data element that you sent is valid, but it is not allowed at this point in the parsing.
-160	Block data error	A problem was found with a block data element. The exact problem cannot be specifically identified.
-161	Invalid block data	A block data element was expected, but it was invalid. For example, an END message was received before the end length was satisfied.
-168	Block data not allowed	A legal block data element was found, but it is not allowed at this point in the parsing.
-170	Expression error	A problem was found with an expression data element. The exact problem cannot be specifically identified.
-171	Invalid expression	An expression data element is not valid. For example, there may be unmatched parentheses or an illegal character.

Instrument Messages
Event Messages

Err#	Message	Verbose/Correction Information
-178	Expression data not allowed	A legal expression data was found, but it is not allowed at this point in the parsing.
-180	Macro error	A problem was found with a macro element. The exact problem cannot be specifically identified.
-181	Invalid outside macro definition	Indicates that a macro parameter placeholder was encountered outside of a macro definition.
-183	Invalid inside macro definition	Indicates that the program message unit sequence, sent with a *DDT or *DMC command, is syntactically invalid
-184	Macro parameter error	Indicates that a command inside the macro definition had the wrong number or type of parameters.

0 Error

Err#	Message	Verbose/Correction Information
0	No error	The queue is empty. Either every error in the queue has been read, or the queue was cleared by power-on or *CLS.

Condition Messages

Condition messages read out in the STATUS message area in the bottom right of the display. Condition messages are classified as either “Errors” or “Warnings.” In the tables in this section, an E in the Error or Warning column means that an error is put up on the front panel and sent out to SCPI when this condition is detected. A W in this column means that a Warning is put up on the front panel, but nothing goes out to SCPI.

For each Condition Messages, there is a corresponding bit in one of the SCPI status registers. These bits are listed in the tables. Some messages exist ONLY as status bits; for these messages the Error or Warning column will contain “status bit only”.

Condition errors 1 to 99, Calibration

These errors correspond to the STATUS:QUESTIONable:CALibration register. Since this register is fanned out to three sub-registers, with summary bits in the main STATUS:QUESTIONable:CALibration register, each sub-register has its own range of error numbers.

Condition Errors 6 to 34, Calibration Skipped

This series of errors corresponds to the bits in the STATUS:QUESTIONable:CALibration:SKIPPed sub-register. The second column in the table shows the corresponding bit.

An event with the error number shown in the table means the condition has been detected. When the condition is cleared, an event with the error number plus 1000 is generated. These error numbers can be seen in the Show Errors screen, along with the DETECTED and CLEARED indicators.

For example, error 6 indicates that the “RF Alignment being skipped” condition has been detected, and error 1006 indicates that failure has been cleared.

This register is summarized as bit 11 of the STATUS:QUESTIONable:CALibration register. See section [“Condition Errors 36 to 64, Calibration Needed or Failed”](#) on page 88.

Err#	Bit in status register	Message	Error or Warning	More Information
6	0	Align RF Skipped	W	
8	1	unused		
10	2	unused		
12	3	unused		
14	4	unused		
16	5	unused		
18	6	unused		
20	7	unused		

Err#	Bit in status register	Message	Error or Warning	More Information
22	8	unused		
24	9	unused		
26	10	unused		
28	11	unused		
30	12	unused		
32	13	unused		
34	14	unused		

Condition Errors 36 to 64, Calibration Needed or Failed

This series of errors corresponds to the bits in the STATUS:QUESTIONable:CALibration register. The second column in the table shows the corresponding bit.

An event with the error number shown in the table means the condition has been detected. When the condition is cleared, an event with the error number plus 1000 is generated. These error numbers can be seen in the Show Errors screen, along with the DETECTED and CLEARED indicators.

For example, error 42 indicates that the “RF Alignment Failure” condition has been detected, and error 1042 indicates that failure has been cleared.

Several bits in this register are “summary bits” for registers at a lower level. There are no error messages associated with these bits; they exist only as status bits, read with a STATUS:QUESTIONable:CALibration? event query or a STATUS:QUESTIONable:CALibration:CONDition? query.

Note that these summary bits summarize the state and history of the event registers at the lower level. This is true even for bits in the STATUS:QUESTIONable:CALibration condition register. This means that:

The summary bits read by the STATUS:QUESTIONable:CALibration:CONDition? query are true if any event bits are set in any of the :CALibration sub-registers :SKIPped, :EXTended:NEEDED or :EXTended:FAILure.

The summary bits read by the STATUS:QUESTIONable:CALibration? event query are true if any event bit has undergone a false-to-true transition with the PTRansition filter set, or a true-to-false transition with the NTRansition filter set, in any of the :CALibration sub-registers :SKIPped, :EXTended:NEEDED or :EXTended:FAILure.

Thus, the summary bits cannot be used to determine the current state of a lower level condition bit; only the state and history of the lower level event bits.

This register is itself summarized as bit 8 of the STATUS:QUESTIONable register. See section [“Condition Errors 601 to 699, Error Summaries” on page 106](#).

Err#	Bit in status register	Message	Error or Warning	More Information
36	0	unused		
38	1	unused		
40	2	TG Alignment Failure	E	
42	3	RF Alignment Failure	E	
44	4	IF Alignment Failure	E	
46	5	LO Alignment Failure	E	
48	6	ADC Alignment Failure	E	
50	7	FM Demod Alignment Failure	E	
52	8	Extended Align Needed Summary	status bit only	This bit is the summary bit for the STATUS:QUESTIONABLE:CALIBRATION:EXTENDED:NEEDED sub-register.
54	9	Extended Align Failure Summary	status bit only	This bit is the summary bit for the STATUS:QUESTIONABLE:CALIBRATION:EXTENDED:FAILURE sub-register.
56	10	unused		
58	11	Align Skipped Sum Summary	status bit only	This bit is the summary bit for the STATUS:QUESTIONABLE:CALIBRATION:SKIPPED sub-register.
60	12	Align Now, RF required	E	
62	13	unused		
64	14	Align Now, All required	E	On PSA, this was error 64

Condition Errors 65 to 92, Calibration Needed (Extended)

This series of errors corresponds to the bits in the STATUS:QUESTIONABLE:CALIBRATION:EXTENDED:NEEDED sub-register. The second column in the table shows the corresponding bit.

An event with the error number shown in the table means the condition has been detected. When the condition is cleared, an event with the error number plus 1000 is generated. These error numbers can be seen in the Show Errors screen, along with the DETECTED and CLEARED indicators.

For example, error 72 indicates that the “Input Attenuation not calibrated” condition has been detected, and error 1072 indicates that failure has been cleared.

Instrument Messages
Condition Messages

This register is summarized as bit 8 of the STATUS:QUESTIONable:CALibration register. See section “Condition Errors 36 to 64, Calibration Needed or Failed” on page 88.

Err#	Bit in status register	Message	Error or Warning	More Information
65	0	unused		
66	1	Align 9kHz-30MHz required	E	An EMI conducted frequency range alignment is needed.
68	2	Align 30MHz-1GHz required	E	An EMI radiated frequency range alignment is needed.
	3	unused		
72	4	Input Attenuation not calibrated	E	Corrected measurements have been requested and the required RF front-end setting of x dB has not been calibrated.
74	5	unused		
76	6	unused		
78	7	unused		
80	8	MPA Align required	W	EXT only
82	9	unused		
84	10	unused		
86	11	unused		
88	12	unused		
90	13	unused		
92	14	unused		

Condition Errors 67 to 95, Calibration Failure (Extended)

This series of errors corresponds to the bits in the STATUS:QUESTIONable:CALibration:EXTended:FAILure sub-register. The second column in the table shows the corresponding bit.

An event with the error number shown in the table means the condition has been detected. When the condition is cleared, an event with the error number plus 1000 is generated. These error numbers can be seen in the Show Errors screen, along with the DETECTED and CLEARED indicators.

For example, error 71 indicates that the Characterize Preselector Failure has been detected, error 1071 indicates that failure has been cleared.

This register is summarized as bit 9 of the STATUS:QUESTIONable:CALibration register. See section

“Condition Errors 36 to 64, Calibration Needed or Failed” on page 88.

Err#	Bit in status register	Message	Error or Warning	More Information
67	0	Align 9kHz to 30MHz failed	W	On PSA, this was error 13749
69	1	Align 30MHz to 1GHz failed	W	On PSA, this was error 13751
71	2	Characterize Preselector failure	W	The preselector characterization routine failed.
73	3	unused		
75	4	unused		
77	5	unused		
79	6	Align Source IQ failed	W	EXT only
81	7	Align Source RF failed	W	EXT only
83	8	MPA Align failed	W	EXT only
85	9	unused		
87	10	unused		
89	11	unused		
91	12	unused		
93	13	unused		
95	14	unused		

Condition Errors 101 to 199, Measurement Integrity

This series of errors corresponds to the bits in the STATUS:QUESTIONable:INTEgrity register. The second column in the table shows the corresponding bit.

An event with the error number shown in the table means the condition has been detected. When the condition is cleared, an event with the error number plus 1000 is generated. These error numbers can be seen in the Show Errors screen, along with the DETECTED and CLEARED indicators.

For example, error 141 indicates an Input Overload condition has been detected, error 1129 indicates that failure has been cleared.

Two bits in this register are “summary bits” for registers at a lower level. There are no error messages associated with these bits; they exist only as status bits, read with a STATUS:QUESTIONable:INTEgrity? event query or a STATUS:QUESTIONable:INTEgrity:CONDition? query.

Instrument Messages
Condition Messages

Note that these summary bits summarize the state and history of the event registers at the lower level. This is true even for bits in the STATUS:QUESTIONable:INTEgrity condition register. This means that:

The summary bits read by the STATUS:QUESTIONable:INTEgrity:CONDition? query are true if any event bits are set in any of the :INTEgrity sub-registers :SIGNal or :UNCalibrated.

The summary bits read by the STATUS:QUESTIONable:INTEgrity? event query are true if any event bit has undergone a false-to-true transition with the PTRansition filter set, or a true-to-false transition with the NTRansition filter set, in any of the :INTEgrity sub-registers :SIGNal or :UNCalibrated

Thus, the summary bits cannot be used to determine the current state of a lower level condition bit; only the state and history of the lower level event bits.

This register is itself summarized as bit 9 of the STATUS:QUESTIONable register. See section [“Condition Errors 601 to 699, Error Summaries” on page 106.](#)

Err#	Bit in status register	Message	Error or Warning	More Information
133	0	Signal Summary	status bit only	This bit is the summary bit for the STATUS:QUESTIONable:INTEgrity:SIGNal sub-register.
135	1	No Result	E	
135	1	No Result; Turn on MCE	E	To calculate Timing and Phase results in the Code Domain Power view of Mod Accuracy, the "Multi Channel Estimator" must be set to ON. Otherwise these results are invalid.
135	1	No Result; Meas invalid with I/Q inputs	E	The current measurement does not support I/Q input; switch to the RF or another input or select a different measurement
137	2	unused		
139	3	Uncalibrated Summary	status bit only	This bit is the summary bit for the STATUS:QUESTIONable:INTEgrity:UNCalibrated sub-register.
141	4	Input Overload	E*	
141	4	Input Overload; ADC over range	E*	The signal at the input to the IF section is too high. You should increase the attenuation or lower the signal level.
141	4	Input Overload; I/Q ADC over range	E*	The I or Q input exceeds the ADC upper limit.

Err#	Bit in status register	Message	Error or Warning	More Information
141	4	Input Overload;I/Q Voltage over range	E*	The input voltage on the I or Q channel exceeds the channel limit. In differential mode the over voltage may occur without causing an ADC overload, for example, if I is at +5.01 V and I-bar is at +5.0 the ADC will be in range but both I and I-bar will exceed the voltage limit.
141	4	Input Overload;RF Preselector Overload	E*	The level at the input of the MXE RF Preselector has exceeded tolerances, reduce the input level
143	5	unused		
145	6	unused		
147	7	Insufficient Data	E	
147	7	Insufficient Data; Incr. Demod Time	E	There is insufficient acquisition data to provide accurate metrics. You should increase the Demod Time to acquire enough data.
147	7	Insufficient Data; frequency list empty	E	A measurement was attempted with List frequency mode or a SCPI query of the frequency list table was made and the frequency list table is empty.
147	7	Insufficient Data; ENR table empty	E	A measurement was attempted or a SCPI query of an ENR table was made and there were no entries in the relevant ENR table (Common, Meas or Cal).
147	7	Insufficient Data; Loss table empty	E	A measurement is attempted or a SCPI query of a before or after loss table is made and there are no entries in the relevant loss table
149	8	Meas Error		
151	9	Memory Error	E	
151	9	Memory Error;Shorten capture interval	E	A shortage of free memory related to longer capture intervals has occurred. The measurement is aborted and all results return invalid values
153	10	I/O Error	E	
153	10	I/O Error; Ext Source needs IP Addr	E	No IP address entered for external source and external LO control is ON.
155	11	Trig Error	E	

Instrument Messages
Condition Messages

Err#	Bit in status register	Message	Error or Warning	More Information
157	12	Invalid Data	Status bit only	This is the “invalid data indicator”, same as the “*” in the upper right corner of the screen. It means that the on-screen annotation does not match the on-screen data, usually because a measurement is pending after a settings change. There is no message in the status line and nothing in the history queue, but there IS an on-screen indication and a status bit.
159	13	Settings Alert	W	
159	13	Settings Alert; LO may overload IF	W	If the sweep type is Swept, the start frequency of the instrument is less than 10 MHz, and you put Swept IF Gain in Manual High, then a warning condition is generated and remains in effect as long as this condition exists. In some older analyzers this was error 1109.
159	13	Settings Alert; Diff probe mismatch; <I Q I,Q>	W	The attenuation values of the two probes on the I and/or Q channels differ by too much for a valid differential reading.
159	13	Settings Alert; Acquisition truncated	W	In the Analog Demod mode, certain extreme settings combinations will result in a required acquisition length in excess of the capacity of the analyzer. Increase the AF Spectrum RBW or the RF Spectrum RBW, decrease the Channel BW, and/or decrease the Demod Waveform Sweep Time.
159	13	Settings Alert; Analog Out settings conflict	W	The user has manually set the Analog Output under the Input/Output menu to a setting that conflicts with the current measurement. There will be no output on the Analog Out port until this conflict is resolved. In most cases, simply set Analog Out to Auto for the optimal setting.
159	13	Settings Alert; I/Q mismatch: <Differential Input Z Attenuation>	W	The impedance, differential, or attenuation settings for the I and Q channels do not match. For valid I+jQ measurements the impedance and differential settings should be the same on both channels and the attenuation should match within 1 dB

Err#	Bit in status register	Message	Error or Warning	More Information
159	13	Settings Alert;Parm/data mismatch	W	For Bluetooth, the detected parameters did not match the data
159	13	Settings Alert;Src pwr ramp>ALC range	W	You have chosen a Power Sweep range that exceeds the ability of the external Source to follow without changing mechanical attenuation. Lower your Power Sweep range.
159	13	Settings Alert;Sweep Rate Unavailable	W	The auto coupled sweep time exceeds the maximum allowed. Therefore, full amplitude accuracy cannot be attained. Please increase the RBW or reduce the span.
159	13	Settings Alert;Span:RBW Ratio too big	W	The chosen large ratio of span to RBW is not possible. Please reduce the span or increase the RBW and/or FFT Width.
161	14	Setting Modified	E	
161	14	Setting Modified; Filter not applied	E	The filter you have selected is larger than the sampling frequency. You should select a different filter.

*the Input Overload error is not reported to the SCPI queue unless the :SYSTEM:ERROR:OVERload ON command has been issued, however it always sets the status bit. See the command reference for details on the :SYSTEM:ERROR:OVERload command.

Condition Errors 201 to 299, Signal Integrity

This series of errors corresponds to the bits in the STATUS:QUESTIONable:INTEgrity:SIGNal sub-register. The second column in the table shows the corresponding bit.

An event with the error number shown in the table means the condition has been detected. When the condition is cleared, an event with the error number plus 1000 is generated. These error numbers can be seen in the Show Errors screen, along with the DETECTED and CLEARED indicators.

For example, error 207 indicates a Burst Not Found condition has been detected, error 1207 indicates that failure has been cleared.

This register is summarized as bit 0 of the STATUS:QUESTIONable:INTEgrity register. See section

Instrument Messages
Condition Messages

“Condition Errors 101 to 199, Measurement Integrity” on page 91.

Err#	Bit in Status Register	Message	Error or Warning	More Information
203	0	unused	E	
205	1	unused	E	

Err#	Bit in Status Register	Message	Error or Warning	More Information
207	2	Burst Not Found	E	<p>The burst signal cannot be detected because of inappropriate parameter settings or incorrect signal.</p> <p>An in appropriate parameter setting could cause the signal to be partially, rather than fully, on the display, Burst Search Threshold and/or Burst Search Length may need to be adjusted.</p> <p>An incorrect signal could have either insufficient power, the rising or falling edges cannot be detected, or the burst is less than 126 microseconds.</p> <p>Carrier signal is not actually bursted.</p> <p>W-CDMA: Either the signal being analyzed has insufficient power, the rising or falling edges cannot be detected, or the burst is less than 126 microseconds.</p> <p>W_CDMA: Cannot synchronize measurement with PRACH channel for Power Control measurement, because the signal cannot be found. Make sure PRACH is present in the W-CDMA uplink signal, and that the preamble signature and scramble code are set correctly.</p> <p>GSM: Data was acquired but a GSM burst was not found, with the timeslot mode disabled.</p> <p>NADC, PDC: A valid burst is not found when the Device is MS.</p> <p>1xEV-DO: Data was acquired but a 1xEV burst was not found, with the timeslot mode disabled.</p> <p>Bluetooth: The burst that has been found does not correspond to the currently selected Bluetooth packet type (the burst length may be too short).</p> <p>WLAN: The instrument cannot find a valid WLAN burst. You may need to extend the search length.</p> <p>In the PSA, this error was reported as one of the following error numbers: 10772, 13104, 10160, 10286, 10420, 10454, 10614, 10904, 10928, 13074, 10287</p>
207	2	Burst not found;with selected Time Slot	E	<p>The selected timeslot does not contain the expected burst.</p>

Instrument Messages
Condition Messages

Err#	Bit in Status Register	Message	Error or Warning	More Information
209	3	Timing Error	E	
209	3	Timing Error;No time ref pilot burst	E	The pilot burst used for time reference is not active.
211	4	Carrier(s) incorrect or missing	E	In the PSA, this error was reported as one of the following error numbers: 10165, 10173, 10178, 10419, 10421, 10535, 10560, 10642, 10648, 10650, 10960
213	5	Freq Out of Range	E	
213	5	Freq Out of Range; System input (IF)	E	One or more system input frequencies are out of range. If using a frequency list, check that all entries are valid for current measurement mode.
213	5	Freq Out of Range; External LO	E	One or more external LO frequencies are out of range. Check that the LO frequency limits are set correctly and check the entered measurement frequencies and measurement mode.
215	6	Sync Error	E	W-CDMA: Cannot sync DPCCH pilot. Cannot synchronize measurement with DPCCH pilot for Power Control measurement, because the pilot signal cannot be found. Make sure DPCCH is present in the W-CDMA uplink signal, and that the slot format and scramble code are set correctly.
215	6	Sync Error;No pilot burst	E	There is no Pilot burst detected.
215	6	Sync Error;Sync code not found	E	Synchronization code is not found in the measured time slot.
215	6	Sync Error;No freq ref pilot burst	E	The pilot burst used for frequency reference is not active.
215	6	Sync Error;Midamble sync fail	E	Failed to find the uplink slot, which caused the synchronization with the midamble to fail.
215	6	Sync Error;Preamble length zero	E	Burst type is "Data" or "Preamble" and the measurement cannot find a Preamble

Err#	Bit in Status Register	Message	Error or Warning	More Information
217	7	Demod Error	E	<p>This error is normally generated because of one of the following reasons:</p> <ol style="list-style-type: none"> 1. There is no carrier signal. 2. Walsh channels other than the pilot are active. 3. There is some other modulation problem that will prevent the measurement from being made. <p>This problem must be corrected before the measurement can continue.</p> <p>cdma 2000 & W-CDMA: Cannot correlate to the input signal and no active channel is found. (from composite EVM measurement) An active channel must meet the default threshold criteria that it is within 20 dB of the highest power code channel. The threshold can be changed using the active set threshold function in the Meas Setup menu.</p> <p>cdmaOne: A correlation failure with the pilot CDMA channel occurred during synchronous demodulation.</p> <p>1xEV-DO: Cannot correlate to the input signal and no active channel is found. (from composite EVM measurement) An active channel must meet the default threshold criteria that it is within 20 dB of the highest power code channel. The threshold can be changed using the active set threshold function in the Meas Setup menu.</p> <p>In the PSA, this error was reported as one of the following error numbers: 10872, 10962, 13070, 10228, 10768</p>
217	7	Demod Error;Can't correlate	E	<p>Cannot correlate to the input signal and no active channel is found. (from composite EVM measurement) An active channel must meet the default threshold criteria that it is within 20 dB of the highest power code channel. The threshold can be changed using the active set threshold function in the Meas Setup menu.</p>
217	7	Demod Error;Data interval too short	E	<p>There are not enough input I/Q pairs for the measurement calculation. This may be caused by an incorrect data capture.</p>
217	7	Demod Error;No active channel	E	<p>There is no active channel detected.</p>
217	7	Demod Error;Not an active slot	E	<p>There is no active slot detected.</p>

Instrument Messages
Condition Messages

Err#	Bit in Status Register	Message	Error or Warning	More Information
217	7	Demod Error;No full subframe found	E	No sub-frame or only part of one sub-frame is detected.
217	7	Demod Error;Muxed bits not found	E	Multiplexed Data Demod Bits are not generated even though Data channel is selected, because all 16 data code channels are not active
217	7	Demod Error;Acq Time too short	E	For Bluetooth, the detected packet type doesn't match the captured packet type because the payload start, end, or data could not be found.
219	8	Signal Too Noisy	E	NADC & PDC: The valid EVM measurement cannot be performed, because the input signal is too noisy. GSM & EDGE: In a GSM measurement, indicates that a burst could not be found in a signal that appears noisy. In the PSA, this error was reported as one of the following error numbers: 10702, 10824, 10906, 10930, 13024, 10626, 111
221	9	Slot Error	E	
221	9	Slot error;No active slot found	E	No valid active slot found in captured data, or no active slot found in captured interval. Synchronization may succeed and pilot found when this message is issued, but no results are included in peak/average calculation.
221	9	Slot Error; No idle slot found	E	No valid idle slot found in captured data, or no idle slot found in captured interval. Synchronization may succeed and pilot found when this message is issued, but no results are included in peak/average calculation.
223	10	unused	E	
225	11	unused	E	
227	12	unused	E	
229	13	unused	E	
231	14	unused	E	

Condition Errors 301 to 399, Uncalibrated Integrity

This series of errors corresponds to the bits in the STATus:QUESTIONable:INTEgrity:UNCalibrated sub-register. The second column in the table shows the corresponding bit.

An event with the error number shown in the table means the condition has been detected. When the condition is cleared, an event with the error number plus 1000 is generated. These error numbers can be seen in the Show Errors screen, along with the DETECTED and CLEARED indicators.

For example, error 301 indicates a Meas Uncal condition has been detected, error 1301 indicates that failure has been cleared.

This register is summarized as bit 3 of the STATus:QUEStionable:INTegrity register. See section [“Condition Errors 101 to 199, Measurement Integrity”](#) on page 91.

Err#	Status Register Bit	Message	Error or Warning	Verbose/Correction Information
301	0	Meas Uncal	W	
303	1	Signal ID on	W	
305	2	No Long Code Phase	W	
307	3	AC coupled: Accy unspec'd <10 MHz	W	AC input coupling will function at lower frequencies, but the performance is not specified below 10 MHz.
309	4	User cal	W	

Instrument Messages
Condition Messages

Err#	Status Register Bit	Message	Error or Warning	Verbose/Correction Information
309	4	User Cal; Cal invalidated	E, W	<p>The existing user cal has been invalidated because of one of the following reasons:</p> <p>Frequency: Setting the frequency outside the current valid user cal set (for example: If the current sweep range is 2 to 3 GHz, then setting the start frequency to 1.9 GHz will invalidate the current user cal. Other frequency changes that will invalidate the user cal are:</p> <ul style="list-style-type: none"> • If the cal was performed at a fixed frequency and you change this frequency. • If you are in "Freq List" mode and you change it to extend beyond the current user cal range. In this case you will see an error message. <p>DUT Type: If the DUT Type parameter changes, causing the measurement frequencies to be pushed outside the current cal.</p> <p>Attenuation: If an attenuation setting is selected but has not been calibrated.</p> <p>Preamp: If set to condition different from current cal settings, for example: if calibrated with the preamp on, turning it off will invalidate the cal.</p> <p>Points: Changing the number of measured frequency points can make the stored preselector offsets become inaccurate and hence invalidate the calibration. This occurs when the following conditions exist:</p> <ul style="list-style-type: none"> • A successful calibration has been performed. • Some measured freq points are > 3.6 GHz. • The new points > 3.6 GHz are located more than 50 MHz away from the current calibration points.

Err#	Status Register Bit	Message	Error or Warning	Verbose/Correction Information
309	4	User Cal; Freq outside cal range	E	The existing user cal has been invalidated because the current measurement frequencies lie partially or wholly outside the range of frequencies used for user-cal. (UNCAL)
309	4	User Cal; Cal will be interpolated	W	The measurement frequency range has been changed such that it is a subset of the calibrated range. (~CAL)
309	4	User Cal; Adjusted for new RBW	W	The measurement RBW has been changed since the last calibration (~CAL)
311	5	Calibration	W	
311	5	Calibration; ENR table extrapolated	W	One or more calibration or measurement frequency points exceed the currently loaded Cal or Meas ENR Table frequency ranges. The corresponding ENR table's lowest frequency ENR value will be re-used for frequencies less than the table range, and the highest frequency ENR value will be re-used for frequencies greater than the table range. (~ENR)
311	5	Calibration; No ENR data present	W	No ENR Data (ENR)
313	6	Source Uncal	W	
313	6	Source Uncal;adj Start Freq or RBW	W	While using a Tracking Source, you must make sure the Start Frequency is high enough to avoid capturing LO feedthrough in the trace. This depends on both Start Freq and RBW. If you get this message, increase your Start Freq or narrow your RBW.
315	7	unused	W	
317	8	unused	W	
319	9	unused	W	
321	10	unused	W	
323	11	unused	W	
325	12	unused	W	
327	13	unused	W	

Err#	Status Register Bit	Message	Error or Warning	Verbose/Correction Information
329	14	unused	W	

Condition Errors 401 to 499, Power

This series of errors corresponds to the bits in the STATUS:QUESTIONABLE:POWER register. The second column in the table shows the corresponding bit.

An event with the error number shown in the table means the condition has been detected. When the condition is cleared, an event with the error number plus 1000 is generated. These error numbers can be seen in the Show Errors screen, along with the DETECTED and CLEARED indicators.

For example, error 409 indicates a 50 MHz Oscillator Unleveled condition has been detected, error 1409 indicates that failure has been cleared.

This register is summarized as bit 3 of the STATUS:QUESTIONABLE register. See section [“Condition Errors 601 to 699, Error Summaries”](#) on page 106.

Err#	Bit in status register	Message	Error or Warning	More Information
401	0	RPP Tripped	W	(not currently in use)
403	1	Source Unleveled	W	
405	2	Source LO Unleveled	E	(not currently in use)
407	3	LO Unleveled	E	(not currently in use)
409	4	unused		
411	5	unused		
413	6	unused		
415	7	unused		
417	8	unused		
419	9	unused		
421	10	unused		
423	11	unused		
425	12	unused		
427	13	unused		
429	14	unused		

Condition Errors 501 to 599, Frequency

This series of errors corresponds to the bits in the STATUS:QUESTIONABLE:FREQUENCY register. The second column in the table shows the corresponding bit.

An event with the error number shown in the table means the condition has been detected. When the condition is cleared, an event with the error number plus 1000 is generated. These error numbers can be seen in the Show Errors screen, along with the DETECTED and CLEARED indicators.

For example, error 503 indicates a Frequency Reference Unlocked condition has been detected, error 1503 indicates that failure has been cleared.

This register is summarized as bit 5 of the STATUS:QUESTIONABLE register. See section “[Condition Errors 601 to 699, Error Summaries](#)” on page 106.

Err#	Bit in status register	Message	Error or Warning	More Information
501	0	Source Synth Unlocked	E	
503	1	Frequency Reference Unlocked	E	
505	2	2 nd LO Unlocked	E	
507	3	unused		
509	4	LO Unlocked	E	
511	5	unused		
513	6	IF Synthesizer Unlocked	E	
515	7	Calibration Oscillator Unlocked	E	
517	8	unused		
519	9	Demodulation	E	
521	10	Ref missing or out of range	E	
521	10	Ref missing or out of range;External	E	The external frequency reference signal is missing or is not within the proper amplitude range. In the PSA, this error was reported as error 622
521	10	Ref missing or out of range;Pulse	E	The pulse reference signal is missing or is not within the proper amplitude range.
523	11	unused		
525	12	unused		

Err#	Bit in status register	Message	Error or Warning	More Information
527	13	unused		
529	14	unused		

Condition Errors 601 to 699, Error Summaries

This series of errors corresponds to the bits in the STATUS:QUESTIONable register, read with a STATUS:QUESTIONable? event query or a STATUS:QUESTIONable:CONDition? query.

The second column in the table shows the corresponding bit in the status register. These bits do not have any corresponding error messages, although error numbers have been reserved for them as seen in the Err# column; they are status bits only.

The bits in the STATUS:QUESTIONable register are “summary bits” for registers at a lower level. Note that these summary bits summarize the state and history of the event registers at the lower level. This is true even for bits in the STATUS:QUESTIONable condition register. This means that:

The summary bits read by the STATUS:QUESTIONable: CONDition? query are true if any event bits are set in any of the :QUESTIONable sub-registers :POWER, :TEMPerature, FREQUency, CALibration or :INTegrity.

The summary bits read by the STATUS:QUESTIONable? event query are true if any event bit has undergone a false-to-true transition with the PTRansition filter set, or a true-to-false transition with the NTRansition filter set, in any of the :QUESTIONable sub-registers :POWER, :TEMPerature, FREQUency, CALibration or :INTegrity.

Thus, the summary bits cannot be used to determine the current state of a lower level condition bit; only the state and history of the lower level event bits.

Err#	Bit in status register	Message	Error or Warning	More Information
601	0	unused		
603	1	unused		
605	2	unused		
607	3	Power	status bit only	This bit is the summary bit for the STATUS:QUESTIONable:POWER sub-register.
609	4	Temperature	status bit only	This bit is the summary bit for the STATUS:QUESTIONable:TEMPerature sub-register.
611	5	Frequency	status bit only	This bit is the summary bit for the STATUS:QUESTIONable:FREQUency sub-register.

Err#	Bit in status register	Message	Error or Warning	More Information
613	6	unused		
615	7	unused		
617	8	Calibration	status bit only	This bit is the summary bit for the STATUS:QUESTIONABLE:CALIBRATION sub-register.
619	9	Integrity	status bit only	This bit is the summary bit for the STATUS:QUESTIONABLE:INTEGRITY sub-register.
621	10	unused		
623	11	unused		
625	12	unused		
627	13	unused		
629	14	unused		

Condition Errors 701 to 799, Operation

This series of errors corresponds to the bits in the STATUS:OPERATION register, read with a STATUS:OPERATION? event query or a STATUS:OPERATION:CONDITION? query.

An event with the error number shown in the table means the condition has been detected. When the condition is cleared, an event with the error number plus 1000 is generated.

For example, error 721 indicates that the DC Coupled condition has been detected; error 1721 indicates that condition has been cleared.

Unless otherwise noted in the Error or Warning column, these are status bits only, with no corresponding error message or number

Err#	Bit in status register	Message	Error or Warning	More Information
701	0	Calibrating	status bit only	
703	1	Settling	status bit only	
705	2	unused		
707	3	Sweeping	status bit only	

Instrument Messages
Condition Messages

Err#	Bit in status register	Message	Error or Warning	More Information
709	4	Measuring	status bit only	
711	5	Waiting for Trigger	status bit only	
713	6	Waiting for Arm	status bit only	
715	7	unused		
717	8	Paused	status bit only	
719	9	Source Sweeping	status bit only	
721	10	DC Coupled	W	
723	11	unused		
725	12	Source Waiting for Trigger	status bit only	
727	13	unused		
729	14	unused		

Condition Errors 801 to 899, Temperature

This series of errors corresponds to the bits in the STATUS:QUESTIONable:TEMPerature register. The second column in the table shows the corresponding bit.

An event with the error number shown in the table means the condition has been detected. When the condition is cleared, an event with the error number plus 1000 is generated. These error numbers can be seen in the Show Errors screen, along with the DETECTED and CLEARED indicators.

For example, error 801 indicates that the Ref Osc Oven Cold condition has been detected; error 1801 indicates that condition has been cleared.

This register is summarized as bit 4 of the STATUS:QUESTIONable register. See section [“Condition Errors 601 to 699, Error Summaries”](#) on page 106.

Err#	Bit in status register	Message	Error or Warning	More Information
801	0	Reference Oscillator Oven Cold	W	(not currently in use)

Err#	Bit in status register	Message	Error or Warning	More Information
803	1	unused		
805	2	unused		
807	3	unused		
809	4	unused		
811	5	unused		
813	6	unused		
815	7	unused		
817	8	unused		
819	9	unused		
821	10	unused		
823	11	unused		
825	12	unused		
827	13	unused		
829	14	unused		

Instrument Messages
Condition Messages

3 STATUS Subsystem

The following graphic shows the current X Status Register Subsystem implementation.

Color version for pdf viewing.

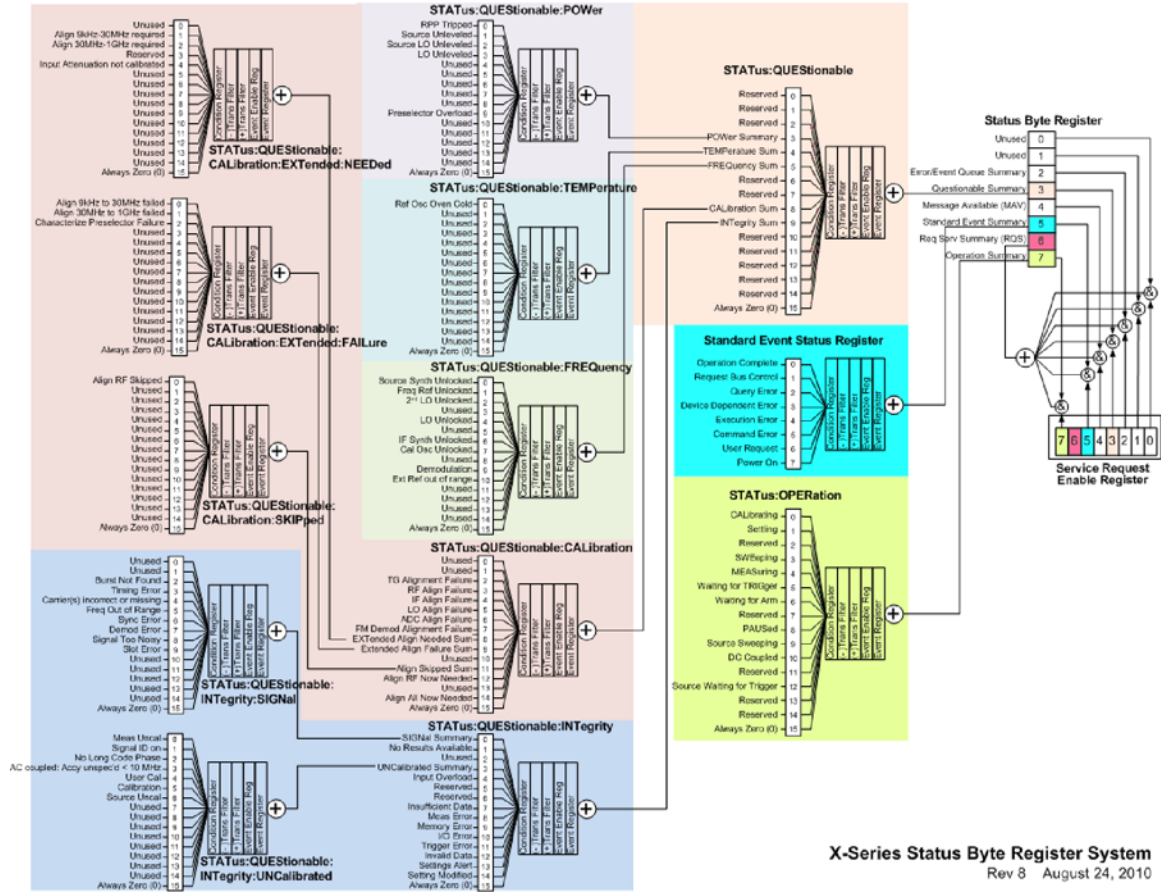

X-Series Status Byte Register System
Rev 8 August 24, 2010

Black and white version for printing.

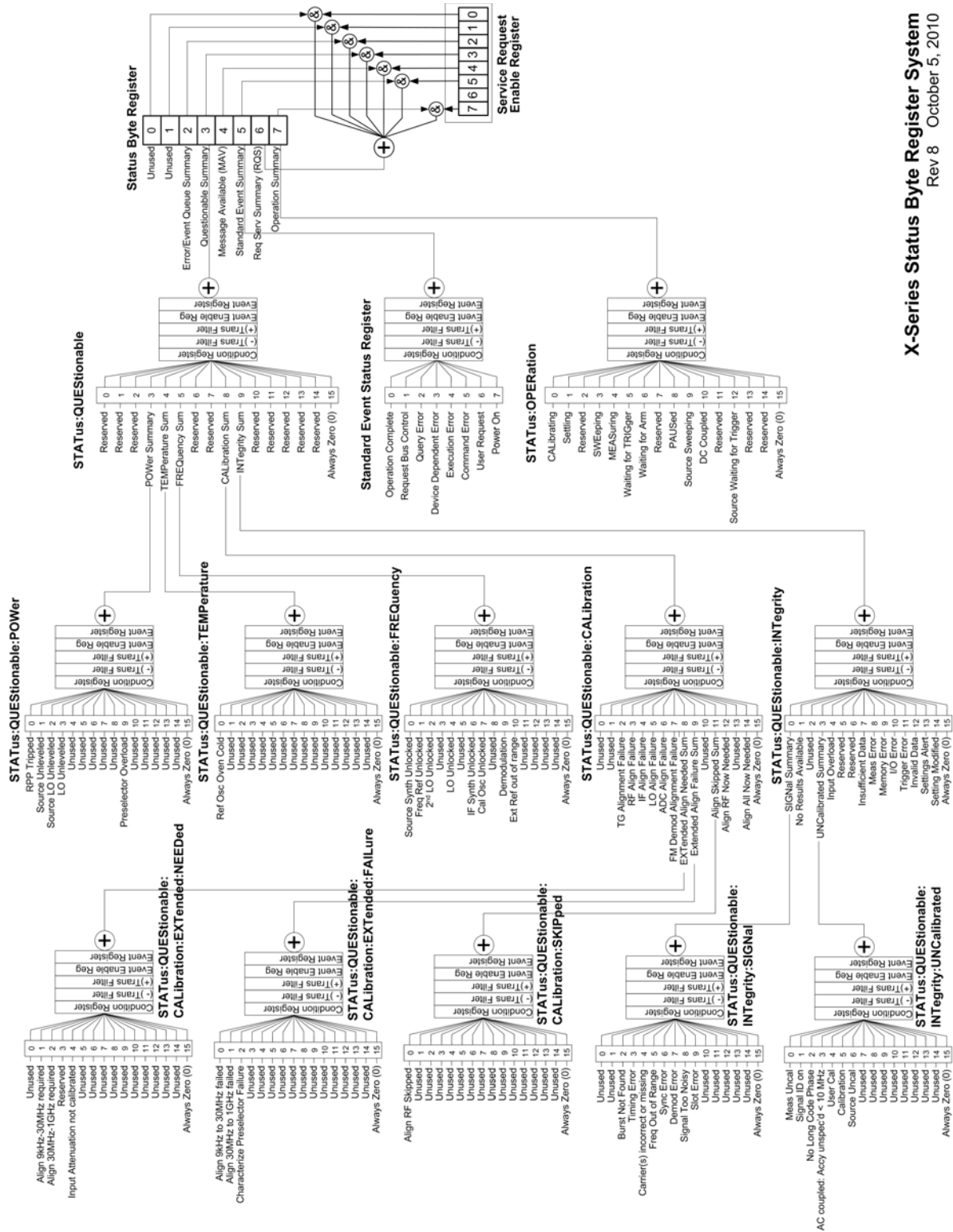

X-Series Status Byte Register System
Rev 8 October 5, 2010

Detailed Description

The STATus subsystem remote commands set and query the status hardware registers. This system of registers monitors various events and conditions in the instrument. Software written to control the instrument may need to monitor some of these events and conditions.

NOTE All status register commands are sequential. Most commands can be started immediately and will overlap with any existing commands that are already running. This is not true of status commands. All the commands in the spectrum analyzer are assumed to be overlapped unless a command description specifically says that it is sequential.

What Are Status Registers

The status system contains multiple registers that are arranged in a hierarchical order. The lower-level status registers propagate their data to the higher-level registers in the data structures by means of summary bits. The status byte register is at the top of the hierarchy and contains general status information for the instrument's events and conditions. All other individual registers are used to determine the specific events or conditions. For a diagram of the registers and their interconnections, see above.

The operation and questionable status registers are sets of registers that monitor the overall instrument condition. They are accessed with the STATus:OPERation and STATus:QUEStionable commands in the STATus command subsystem. Each register set is made up of five registers:

- Condition Register—It reports the real-time state of the signals monitored by this register set. There is no latching or buffering for a condition register.
- Positive Transition Register—This filter register controls which signals will set a bit in the event register when the signal makes a low to high transition (when the condition bit changes from 0 to 1).
- Negative Transition Register—This filter register controls which signals will set a bit in the event register when the signal makes a high to low transition (when the condition bit changes from 1 to 0).
- Event Register—It latches any signal state changes, in the way specified by the filter registers. Bits in the event register are never cleared by signal state changes. Event registers are cleared when read. They are also cleared by *CLS and by presetting the instrument.
- Event Enable Register—It controls which of the bits, being set in the event register, will be summarized as a single output for the register set. Summary bits are then used by the next higher register.

The STATus:QUEStionable registers report abnormal operating conditions. The status register hierarchy is:

1. The summary outputs from the six STATus:QUEStionable:<keyword> detail registers are inputs to the STATus:QUEStionable register.
2. The summary output from the STATus:QUEStionable register is an input to the Status Byte Register. See the overall system in Figure at the beginning of this section.

The STATus:OPERation register set has no summarized inputs. The inputs to the STATus:OPERation:CONDition register indicate the real time state of the instrument. The STATus:OPERation:EVENT register summary output is an input to the Status Byte Register.

What Are Status Register SCPI Commands

Most monitoring of the instrument conditions is done at the highest level using the IEEE common commands indicated below. Complete command descriptions are available in the IEEE commands section at the beginning of the language reference. Individual status registers can be set and queried using the commands in the STATus subsystem of the language reference.

- *CLS (clear status) clears the status byte by emptying the error queue and clearing all the event registers.
- *ESE, *ESE? (event status enable) sets and queries the bits in the enable register part of the standard event status register.
- *ESR? (event status register) queries and clears the event register part of the standard event status register.
- *OPC, *OPC? (operation complete) sets the standard event status register to monitor the completion of all commands. The query stops any new commands from being processed until the current processing is complete, then returns a '1'.
- *PSC, *PSC? (power-on state clear) sets the power-on state so that it clears the service request enable register and the event status enable register at power on.
- *SRE, *SRE? (service request enable) sets and queries the value of the service request enable register.
- *STB? (status byte) queries the value of the status byte register without erasing its contents.

How to Use the Status Registers

A program often needs to be able to detect and manage error conditions or changes in instrument status. There are two methods you can use to programmatically access the information in status registers:

- The polling method
- The service request (SRQ) method

In the polling method, the instrument has a passive role. It only tells the controller that conditions have changed when the controller asks the right question. In the SRQ method, the instrument takes a more active role. It tells the controller when there has been a condition change without the controller asking. Either method allows you to monitor one or more conditions.

The polling method works well if you do not need to know about changes the moment they occur. The SRQ method should be used if you must know immediately when a condition changes. To detect a change using the polling method, the program must repeatedly read the registers.

Use the SRQ method when:

- you need time-critical notification of changes
- you are monitoring more than one device which supports SRQs

- you need to have the controller do something else while waiting
- you can't afford the performance penalty inherent to polling

Use polling when:

- your programming language/development environment does not support SRQ interrupts
- you want to write a simple, single-purpose program and don't want the added complexity of setting up an SRQ handler
- To monitor a condition:
 - a. Determine which register contains the bit that reports the condition.
 - b. Send the unique SCPI query that reads that register.
 - c. Examine the bit to see if the condition has changed.

You can monitor conditions in different ways.

- Check the current instrument hardware and firmware status.

Do this by querying the condition registers which continuously monitor status. These registers represent the current state of the instrument. Bits in a condition register are updated in real time. When the condition monitored by a particular bit becomes true, the bit is set to 1. When the condition becomes false, the bit is reset to 0.

- Monitor a particular condition (bit).

You can enable a particular bit(s), using the event enable register. The instrument will then monitor that particular condition(s). If the bit becomes true (0 to 1 transition) in the event register, it will stay set until the event register is cleared. Querying the event register allows you to detect that this condition occurred even if the condition no longer exists. The event register can only be cleared by querying it or sending the *CLS command.

- Monitor a particular type of change in a condition (bit).
 - The transition registers are preset to register if the condition goes from 0 to 1 (false to true, or a positive transition).
 - This can be changed so the selected condition is detected if the bit goes from 1 to 0 (true to false, or a negative transition).
 - It can also be set for both types of transitions occurring.
 - Or it can be set for neither transition. If both transition registers are set to 0 for a particular bit position, that bit will not be set in the event register for either type of change.

Using a Status Register

Each bit in a register is represented by a numerical value based on its location. See figure below. This number is sent with the command to enable a particular bit. If you want to enable more than one bit, you would send the sum of all the bits that you want to monitor.

Figure: Status Register Bit Values

method, you must:

1. Determine which bit monitors the condition.
2. Determine how that bit reports to the request service (RQS) bit of the status byte.
3. Send SCPI commands to enable the bit that monitors the condition and to enable the summary bits that report the condition to the RQS bit.
4. Enable the controller to respond to service requests.

When the condition changes, the instrument sets its RQS bit. The controller is informed of the change as soon as it occurs. As a result, the time the controller would otherwise have used to monitor the condition can be used to perform other tasks. Your program determines how the controller responds to the SRQ.

Generating a Service Request

To use the SRQ method, you must understand how service requests are generated. Bit 6 of the status byte register is the request service (RQS) bit. The *SRE command is used to configure the RQS bit to report changes in instrument status. When such a change occurs, the RQS bit is set. It is cleared when the status byte register is queried using *SRE? (with a serial poll.) It can be queried without erasing the contents with *STB?.

When a register set causes a summary bit in the status byte to change from 0 to 1, the instrument can initiate the service request (SRQ) process. However, the process is only initiated if both of the following conditions are true:

- The corresponding bit of the service request enable register is also set to 1.
- The instrument does not have a service request pending. (A service request is considered to be pending between the time the instrument's SRQ process is initiated and the time the controller reads the status byte register.)

The SRQ process sets the SRQ true. It also sets the status byte's request service (RQS) bit to 1. Both actions are necessary to inform the controller that the instrument requires service. Setting the SRQ line only informs the controller that some device on the bus requires service. Setting the RQS bit allows the controller to determine which instrument requires service.

If your program enables the controller to detect and respond to service requests, it should instruct the controller to perform a serial poll when the SRQ is set true. Each device on the bus returns the contents of its status byte register in response to this poll. The device whose RQS bit is set to 1 is the device that requested service.

When you read the instrument's status byte register with a serial poll, the RQS bit is reset to 0. Other bits in the register are not affected.

If the status register is configured to SRQ on end-of-measurement and the measurement is in continuous mode, then restarting a measurement (INIT command) can cause the measuring bit to pulse low. This causes an SRQ when you have not actually reached the "end-of-measurement" condition. To avoid this:

1. Set INITiate:CONTinuous off.
2. Set/enable the status registers.
3. Restart the measurement (send INIT).

Status Register System

The hardware status registers are combined to form the instrument status system. Specific status bits are assigned to monitor various aspects of the instrument operation and status. See the diagram of the status system above for information about the bit assignments and status register interconnections.

The Status Byte Register

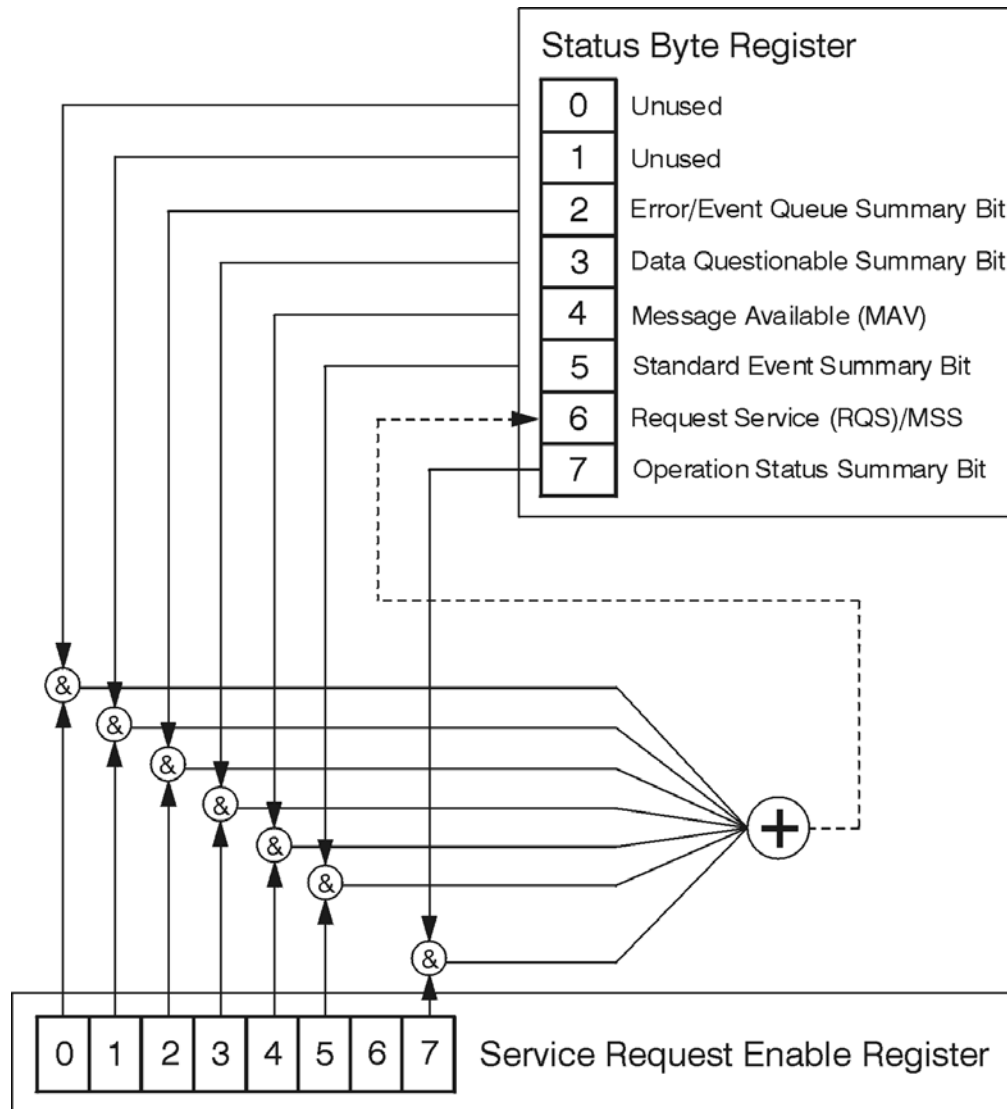

ck776a

The RQS bit is read and reset by a serial poll. The same bit position (MSS) is read, non-destructively by the *STB? command. If you serial poll bit 6 it is read as RQS, but if you send *STB it reads bit 6 as MSS. For more information refer to IEEE 488.2 standards, section 11.

	Description	Standard Operation Status Summary Bit	Request Service (RQS) Summary Bit	Standard Event Status Summary Bit	Message Available (MAV)	Data Questionable Status Summary Bit	Error/Event Queue Summary Bit	Unused	Unused
Bit Number	7	6	5	4	3	2	1	0	0

*STB?

Status Byte Register

ck725a

Bit	Description
0, 1	These bits are always set to 0.
2	A 1 in this bit position indicates that the SCPI error queue is not empty which means that it contains at least one error message.
3	A 1 in this bit position indicates that the data questionable summary bit has been set. The data questionable event register can then be read to determine the specific condition that caused this bit to be set.
4	A 1 in this bit position indicates that the instrument has data ready in the output queue. There are no lower status groups that provide input to this bit.
5	A 1 in this bit position indicates that the standard event summary bit has been set. The standard event status register can then be read to determine the specific event that caused this bit to be set.
6	A 1 in this bit position indicates that the instrument has at least one reason to report a status change. This bit is also called the master summary status bit (MSS).
7	A 1 in this bit position indicates that the standard operation summary bit has been set. The standard operation event register can then be read to determine the specific condition that caused this bit to be set.

To query the status byte register, send the command *STB?. The response will be the decimal sum of the bits which are set to 1. For example, if bit number 7 and bit number 3 are set to 1, the decimal sum of the 2 bits is 128 plus 8. So the decimal value 136 is returned. The *STB command does not clear the status register.

In addition to the status byte register, the status byte group also contains the service request enable register. This register lets you choose which bits in the status byte register will trigger a service request.

STATus Subsystem
Detailed Description

Send the *SRE <integer> command where <integer> is the sum of the decimal values of the bits you want to enable plus the decimal value of bit 6. For example, assume that you want to enable bit 7 so that whenever the standard operation status register summary bit is set to 1 it will trigger a service request. Send the command *SRE 192 (because $192 = 128 + 64$). You must always add 64 (the numeric value of RQS bit 6) to your numeric sum when you enable any bits for a service request. The command *SRE? returns the decimal value of the sum of the bits previously enabled with the *SRE <integer> command.

The service request enable register presets to zeros (0).

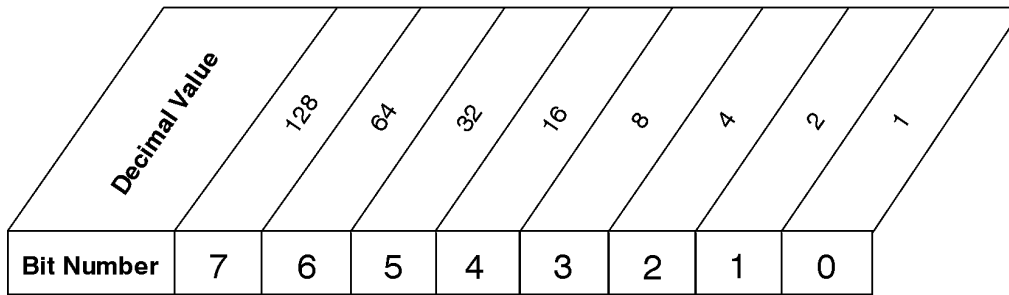

*SRE <num>
*SRE?

Service Request Enable Register

ck726a

Standard Event Status Register

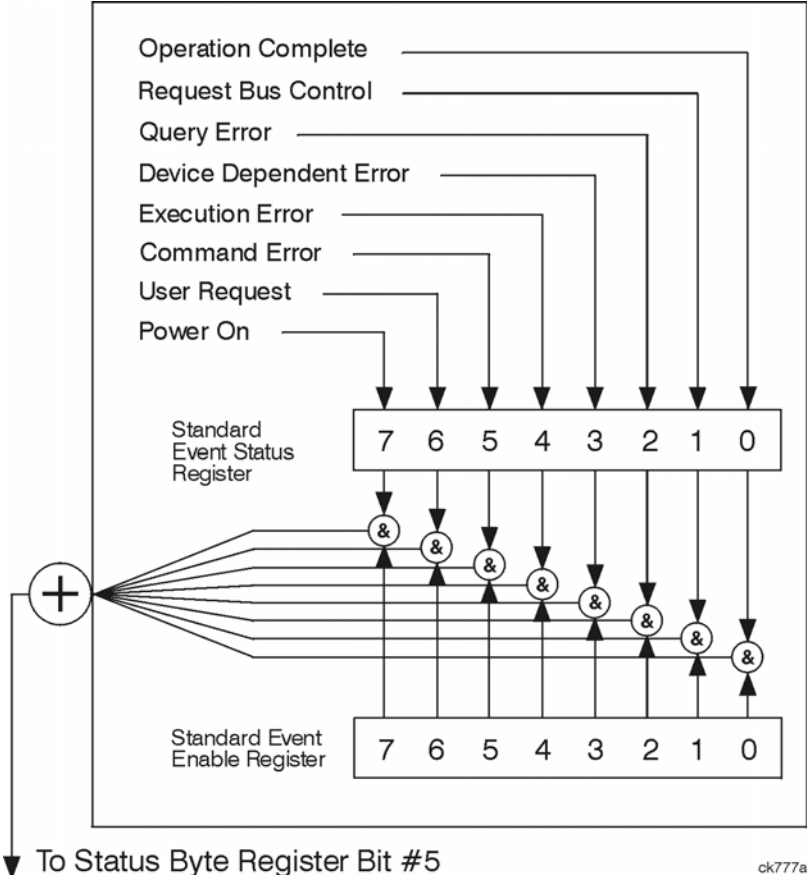

The standard event status register contains the following bits:

Bit Number	7	6	5	4	3	2	1	0
Description	Power On	User Request Key (Local)	Command Error	Execution Error	Device Dependent Error	Query Error	Request Control	Operation Complete

*ESR?

Standard Event Status Register

ck727a

STATus Subsystem
Detailed Description

Bit	Description
0	A 1 in this bit position indicates that all pending operations were completed following execution of the *OPC command.
1	This bit is for GPIB handshaking to request control. Currently it is set to 0 because there are no implementations where the spectrum analyzer controls another instrument.
2	A 1 in this bit position indicates that a query error has occurred. Query errors have SCPI error numbers from -499 to -400.
3	A 1 in this bit position indicates that a device dependent error has occurred. Device dependent errors have SCPI error numbers from -399 to -300 and 1 to 32767.
4	A 1 in this bit position indicates that an execution error has occurred. Execution errors have SCPI error numbers from -299 to -200.
5	A 1 in this bit position indicates that a command error has occurred. Command errors have SCPI error numbers from -199 to -100.
6	A 1 in this bit position indicates that the LOCAL key has been pressed. This is true even if the instrument is in local lockout mode.
7	A 1 in this bit position indicates that the instrument has been turned off and then on.

The standard event status register is used to determine the specific event that set bit 5 in the status byte register. To query the standard event status register, send the command *ESR?. The response will be the decimal sum of the bits which are enabled (set to 1). For example, if bit number 7 and bit number 3 are enabled, the decimal sum of the 2 bits is 128 plus 8. So the decimal value 136 is returned.

In addition to the standard event status register, the standard event status group also contains a standard event status enable register. This register lets you choose which bits in the standard event status register will set the summary bit (bit 5 of the status byte register) to 1. Send the *ESE <integer> command where <integer> is the sum of the decimal values of the bits you want to enable. For example, to enable bit 7 and bit 6 so that whenever either of those bits is set to 1, the standard event status summary bit of the status byte register will be set to 1, send the command *ESE 192 (128 + 64). The command *ESE? returns the decimal value of the sum of the bits previously enabled with the *ESE <integer> command.

The standard event status enable register presets to zeros (0).

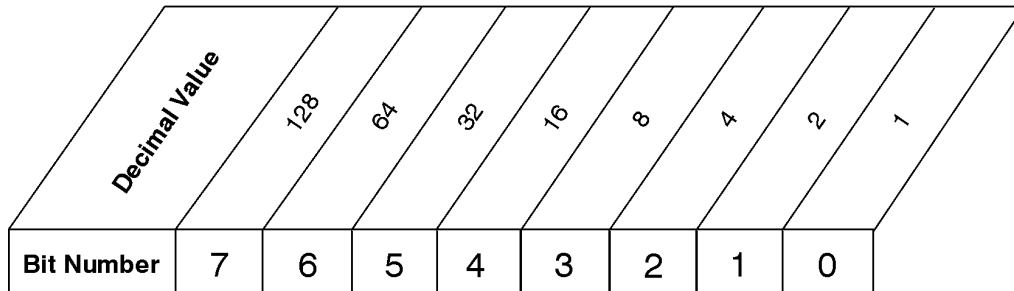

*ESE <num>
*ESE?

Standard Event Status Enable Register

ck728a

Operation and Questionable Status Registers

The operation and questionable status registers are registers that monitor the overall instrument condition. They are accessed with the STATus:OPERation and STATus:QUEStionable commands in the STATus command subsystem. See the figure at the beginning of this chapter.

Operation Status Register

The operation status register monitors the current instrument measurement state. It checks to see if the instrument is calibrating, sweeping, or waiting for a trigger. For more information see the *OPC? command located in the IEEE Common Commands section.

Bit	Condition	Operation
0	Calibrating	The instrument is busy executing its Align Now process
3	Sweeping	The instrument is busy taking a sweep.
4	Measuring	The instrument is busy making a measurement. Measurements often require multiple sweeps. They are initiated by keys under the MEASURE key or with the MEASure group of commands. The bit is valid for most X-Series Modes.
5	Waiting for trigger	The instrument is waiting for the trigger conditions to be met, then it will trigger a sweep or measurement.

Questionable Status Register

The questionable status register monitors the instrument's condition to see if anything questionable has happened to it. It is looking for anything that might cause an error or a bad measurement like a hardware problem, an out of calibration situation, or a unusual signal. All the bits are summary bits from lower-level event registers.

Bit	Condition	Operation
3	Power summary	The instrument hardware has detected a power unlevelled condition.
4	Temperature summary	The instrument is still warming up.
5	Frequency summary	The instrument hardware has detected an unlocked condition or a problem with the external frequency reference.
8	Calibration summary	The instrument has detected a hardware problem while doing the automatic internal alignment process.
9	Integrity summary	The instrument has detected a questionable measurement condition such as: bad timing, bad signal/data, timeout problem, signal overload, or "meas uncal".

STATus Subsystem Command Descriptions

The STATus subsystem controls the SCPI-defined instrument status reporting structures. Each status register has a set of five commands used for querying or masking that particular register.

Numeric values for bit patterns can be entered using decimal or hexadecimal representations. (i.e. 0 to 32767 is equivalent to #H0 to #H7FFF. It is also equal to all ones, 11111111111111) See the SCPI Basics information about using bit patterns for variable parameters.

Operation Register

Operation Condition Query

This query returns the decimal value of the sum of the bits in the Status Operation Condition register.

NOTE The data in this register is continuously updated and reflects the current conditions.

Mode	All
Remote Command	:STATus:OPERation:CONDition?
Example	STAT:OPER:COND?
Preset	0
Status Bits/OPC dependencies	Sequential command
Initial S/W Revision	Prior to A.02.00
Help Map ID	0

Operation Enable

This command determines which bits in the Operation Event register, will set the Operation Status Summary bit (bit 7) in the Status Byte Register. The variable <integer> is the sum of the decimal values of the bits you want to enable.

NOTE The preset condition is to have all bits in this enable register set to 0. To have any Operation Events reported to the Status Byte Register, one or more bits need to be set to 1.

STATus Subsystem
STATus Subsystem Command Descriptions

Mode	All
Remote Command	:STATus:OPERation:ENABle <integer> :STATus:OPERation:ENABle?
Example	STAT:OPER:ENAB 1 Sets the register so that Align Now operation will be reported to the Status Byte Register.
Preset	0
Min	0
Max	32767
Status Bits/OPC dependencies	Sequential command
Initial S/W Revision	Prior to A.02.00
Help Map ID	0

Operation Event Query

This query returns the decimal value of the sum of the bits in the Operation Event register.

NOTE The register requires that the associated PTR or NTR filters be set before a condition register bit can set a bit in the event register. The data in this register is latched until it is queried. Once queried, the register is cleared.

Mode	All
Remote Command	:STATus:OPERation[:EVENT]?
Example	STAT:OPER?
Preset	0
Status Bits/OPC dependencies	Sequential command
Initial S/W Revision	Prior to A.02.00
Help Map ID	0

Operation Negative Transition

This command determines which bits in the Operation Condition register will set the corresponding bit in the Operation Event register when the condition register bit has a negative transition (1 to 0). The variable <integer> is the sum of the decimal values of the bits that you want to enable.

Mode	All
Remote Command	:STATus:OPERation:NTRansition <integer> :STATus:OPERation:NTRansition?
Example	STAT:OPER:NTR 1 Align Now operation complete will be reported to the Status Byte Register.
Preset	0
Min	0
Max	32767
Status Bits/OPC dependencies	Sequential command
Initial S/W Revision	Prior to A.02.00
Help Map ID	0

Operation Positive Transition

This command determines which bits in the Operation Condition register will set the corresponding bit in the Operation Event register when the condition register bit has a positive transition (0 to 1). The variable <integer> is the sum of the decimal values of the bits that you want to enable.

Mode	All
Remote Command	:STATus:OPERation:PTRansition <integer> :STATus:OPERation:PTRansition?
Example	STAT:OPER:PTR 1 Align Now operation beginning will be reported to the Status Byte Register.
Preset	32767
Min	0
Max	32767
Status Bits/OPC dependencies	Sequential command
Initial S/W Revision	Prior to A.02.00
Help Map ID	0

Preset the Status Byte

Sets bits in most of the enable and transition registers to their default state. It presets all the Transition Filters, Enable Registers, and the Error/Event Queue Enable. It has no effect on Event Registers, Error/Event QUEue, IEEE 488.2 ESE, and SRE Registers as described in IEEE Standard 488.2–1992, IEEE Standard Codes, Formats, Protocols, and Common Commands for Use with ANSI/IEEE Std 488.1–1987. New York, NY, 1992.

Remote Command	:STATus:PRESet
Example	STAT:PRES
Initial S/W Revision	Prior to A.02.00
Help Map ID	0

Questionable Register

Questionable Condition

This query returns the decimal value of the sum of the bits in the Questionable Condition register.

NOTE The data in this register is continuously updated and reflects the current conditions.

Mode	All
Remote Command	:STATus:QUEStionable:CONDition?
Example	STAT:QUES:COND?
Preset	0
Status Bits/OPC dependencies	Sequential command
Initial S/W Revision	Prior to A.02.00
Help Map ID	0

Questionable Enable

This command determines which bits in the Questionable Event register will set the Questionable Status Summary bit (bit3) in the Status Byte Register. The variable <integer> is the sum of the decimal values of the bits you want to enable.

NOTE The preset condition is all bits in this enable register set to 0. To have any Questionable Events reported to the Status Byte Register, one or more bits need to be set to 1. The Status Byte Event Register should be queried after each measurement to check the Questionable Status Summary (bit 3). If it is equal to 1, a condition during the test may have made the test results invalid. If it is equal to 0,

this indicates that no hardware problem or measurement problem was detected by the analyzer.

Mode	All
Remote Command	:STATus:QUESTionable:ENABle 16 Sets the register so that temperature summary will be reported to the Status Byte Register :STATus:QUESTionable:ENABle?
Example	STAT:OPER:PTR 1 Align Now operation beginning will be reported to the Status Byte Register.
Preset	0
Min	0
Max	32767
Status Bits/OPC dependencies	Sequential command
Initial S/W Revision	Prior to A.02.00
Help Map ID	0

Questionable Event Query

This query returns the decimal value of the sum of the bits in the Questionable Event register.

NOTE The register requires that the associated PTR or NTR filters be set before a condition register bit can set a bit in the event register. The data in this register is latched until it is queried. Once queried, the register is cleared.

Mode	All
Remote Command	:STATus:QUESTionable[:EVENT]?
Example	STAT:QUES?
Preset	0
Status Bits/OPC dependencies	Sequential command
Initial S/W Revision	Prior to A.02.00
Help Map ID	0

Questionable Negative Transition

This command determines which bits in the Questionable Condition register will set the corresponding bit in the Questionable Event register when the condition register bit has a negative transition (1 to 0).

STATus Subsystem
STATus Subsystem Command Descriptions

The variable <integer> is the sum of the decimal values of the bits that you want to enable.

Mode	All
Remote Command	:STATus:QUESTionable:NTRansition 16 Temperature summary 'questionable cleared' will be reported to the Status Byte Register. :STATus:QUESTionable:NTRansition?
Example	STAT:QUES:NTR 16 Temperature summary 'questionable cleared' will be reported to the Status Byte Register.
Preset	0
Min	0
Max	32767
Status Bits/OPC dependencies	Sequential command
Initial S/W Revision	Prior to A.02.00
Help Map ID	0

Questionable Positive Transition

This command determines which bits in the Questionable Condition register will set the corresponding bit in the Questionable Event register when the condition register bit has a positive transition (0 to 1). The variable <integer> is the sum of the decimal values of the bits that you want to enable.

Mode	All
Remote Command	:STATus:QUESTionable:PTRansition <integer> :STATus:QUESTionable:PTRansition?
Example	STAT:QUES:PTR 16 Temperature summary 'questionable asserted' will be reported to the Status Byte Register.
Preset	32767
Min	0
Max	32767
Status Bits/OPC dependencies	Sequential command
Initial S/W Revision	Prior to A.02.00
Help Map ID	0

Questionable Calibration Register

Questionable Calibration Condition

This query returns the decimal value of the sum of the bits in the Questionable Calibration Condition register.

NOTE The data in this register is continuously updated and reflects the current conditions.

Mode	All
Remote Command	:STATus:QUESTionable:CALibration:CONDition?
Example	STAT:QUES:CAL:COND?
Preset	0
Status Bits/OPC dependencies	Sequential command
Initial S/W Revision	Prior to A.02.00
Help Map ID	0

Questionable Calibration Enable

This command determines which bits in the Questionable Calibration Condition Register will set bits in the Questionable Calibration Event register, which also sets the Calibration Summary bit (bit 8) in the Questionable Register. The variable <integer> is the sum of the decimal values of the bits you want to enable.

Mode	All
Remote Command	:STATus:QUESTionable:CALibration:ENABle <integer> :STATus:QUESTionable:CALibration:ENABle?
Example	STAT:QUES:CAL:ENAB 16384 Can be used to query if an alignment is needed, if you have turned off the automatic alignment process.
Min	0
Max	32767
Status Bits/OPC dependencies	Sequential command
Initial S/W Revision	Prior to A.02.00
Help Map ID	0

Questionable Calibration Event Query

This query returns the decimal value of the sum of the bits in the Questionable Calibration Event register.

NOTE The register requires that the associated PTR or NTR filters be set before a condition register bit can set a bit in the event register. The data in this register is latched until it is queried. Once queried, the register is cleared.

Mode	All
Remote Command	:STATus:QUESTionable:CALibration[:EVENT]?
Example	STAT:QUES:CAL?
Preset	0
Status Bits/OPC dependencies	Sequential command
Initial S/W Revision	Prior to A.02.00
Help Map ID	0

Questionable Calibration Negative Transition

This command determines which bits in the Questionable Calibration Condition register will set the corresponding bit in the Questionable Calibration Event register when the condition register bit has a negative transition (1 to 0). The variable <integer> is the sum of the decimal values of the bits that you want to enable.

Mode	All
Remote Command	:STATus:QUESTionable:CALibration:NTRansition <integer> :STATus:QUESTionable:CALibration:NTRansition?
Example	STAT:QUES:CAL:NTR 16384 Alignment is not required.
Preset	0
Min	0
Max	32767
Status Bits/OPC dependencies	Sequential command
Initial S/W Revision	Prior to A.02.00
Help Map ID	0

Questionable Calibration Positive Transition

This command determines which bits in the Questionable Calibration Condition register will set the corresponding bit in the Questionable Calibration Event register when the condition register bit has a positive transition (0 to 1). The variable <integer> is the sum of the decimal values of the bits that you want to enable.

Mode	All
------	-----

Remote Command	:STATus:QUESTionable:CALibration:PTRansition <integer> :STATus:QUESTionable:CALibration:PTRansition?
Example	STAT:QUES:CAL:PTR 16384 Alignment is required.
Preset	32767
Min	0
Max	32767
Status Bits/OPC dependencies	Sequential command
Initial S/W Revision	Prior to A.02.00
Help Map ID	0

Questionable Calibration Skipped Register

Questionable Calibration Skipped Condition

This query returns the decimal value of the sum of the bits in the Questionable Calibration Skipped Condition register.

NOTE The data in this register is continuously updated and reflects the current conditions.

Mode	All
Remote Command	:STATus:QUESTionable:CALibration:SKIpped:CONDition?
Example	STAT:QUES:CAL:SKIP:COND?
Preset	0
Status Bits/OPC dependencies	Sequential command
Initial S/W Revision	Prior to A.02.00
Help Map ID	0

Questionable Calibration Skipped Enable

This command determines which bits in the Questionable Calibration Skipped Condition Register will set bits in the Questionable Calibration Skipped Event register, which also sets bit 11 of the Questionable Calibration Register. The variable <integer> is the sum of the decimal values of the bits you want to enable.

Mode	All
Remote Command	:STATus:QUESTionable:CALibration:SKIpped:ENABLE <integer> :STATus:QUESTionable:CALibration:SKIpped:ENABLE?

STATus Subsystem
STATus Subsystem Command Descriptions

Example	STAT:QUES:CAL:SKIP:ENAB 1 Can be used to query if an EMI alignment skipped condition is detected
Preset	32767
Min	0
Max	32767
Status Bits/OPC dependencies	Sequential command
Initial S/W Revision	Prior to A.02.00
Help Map ID	0

Questionable Calibration Skipped Event Query

This query returns the decimal value of the sum of the bits in the Questionable Calibration Event register.

NOTE The register requires that the associated PTR or NTR filters be set before a condition register bit can set a bit in the event register. The data in this register is latched until it is queried. Once queried, the register is cleared.

Mode	All
Remote Command	:STATus:QUESTionable:CALibration:SKIpped[:EVENT]?
Example	STAT:QUES:CAL:SKIP?
Preset	0
Status Bits/OPC dependencies	Sequential command
Initial S/W Revision	Prior to A.02.00
Help Map ID	0

Questionable Calibration Skipped Negative Transition

This command determines which bits in the Questionable Calibration Skipped Condition register will set the corresponding bit in the Questionable Calibration Skipped Event register when the condition register bit has a negative transition (1 to 0). The variable <integer> is the sum of the decimal values of the bits that you want to enable.

Mode	All
Remote Command	:STATus:QUESTionable:CALibration:SKIpped:NTRansition <integer> :STATus:QUESTionable:CALibration:SKIpped:NTRansition?
Example	STAT:QUES:CAL:SKIP:NTR 1 Align RF skipped is not required.
Preset	0

Min	0
Max	32767
Status Bits/OPC dependencies	Sequential command
Initial S/W Revision	Prior to A.02.00
Help Map ID	0

Questionable Calibration Skipped Positive Transition

This command determines which bits in the Questionable Calibration Skipped Condition register will set the corresponding bit in the Questionable Calibration Skipped Event register when the condition register bit has a positive transition (0 to 1). The variable <integer> is the sum of the decimal values of the bits that you want to enable.

Mode	All
Remote Command	:STATus:QUESTionable:CALibration:SKIPped:PTRansition <integer> :STATus:QUESTionable:CALibration:SKIPped:PTRansition?
Example	STAT:QUES:CAL:SKIP:PTR 1 Align RF skipped is required.
Preset	32767
Min	0
Max	32767
Status Bits/OPC dependencies	Sequential command
Initial S/W Revision	Prior to A.02.00
Help Map ID	0

Questionable Calibration Extended Failure Register

Questionable Calibration Extended Failure Condition

This query returns the decimal value of the sum of the bits in the Questionable Calibration Extended Failure Condition register.

NOTE The data in this register is continuously updated and reflects the current conditions.

Mode	All
Remote Command	:STATus:QUESTionable:CALibration:EXTended:FAILure:CONDi tion?
Example	STAT:QUES:CAL:EXT:FAIL:COND?

STATus Subsystem
STATus Subsystem Command Descriptions

Preset	0
Status Bits/OPC dependencies	Sequential command
Initial S/W Revision	Prior to A.02.00
Help Map ID	0

Questionable Calibration Extended Failure Enable

This command determines which bits in the Questionable Calibration Extended Failure Condition Register will set bits in the Questionable Calibration Extended Failure Event register, which also sets bit 9 of the Questionable Calibration Register. The variable <integer> is the sum of the decimal values of the bits you want to enable.

Mode	All
Remote Command	:STATus:QUESTionable:CALibration:EXTended:FAILure:ENABLe <integer> :STATus:QUESTionable:CALibration:EXTended:FAILure:ENABLe?
Example	STAT:QUES:CAL:EXT:FAIL:ENAB 1 Can be used to query if an EMI conducted alignment is needed.
Preset	32767
Min	0
Max	32767
Status Bits/OPC dependencies	Sequential command
Initial S/W Revision	Prior to A.02.00
Help Map ID	0

Questionable Calibration Extended Failure Event Query

This query returns the decimal value of the sum of the bits in the Questionable Calibration Extended Failure Event register.

NOTE The register requires that the associated PTR or NTR filters be set before a condition register bit can set a bit in the event register. The data in this register is latched until it is queried. Once queried, the register is cleared.

Mode	All
Remote Command	:STATus:QUESTionable:CALibration:EXTended:FAILure[:EVENt]?
Example	STAT:QUES:CAL:EXT:FAIL?
Preset	0

Status Bits/OPC dependencies	Sequential command
Initial S/W Revision	Prior to A.02.00
Help Map ID	0

Questionable Calibration Extended Failure Negative Transition

This command determines which bits in the Questionable Calibration Extended Failure Condition register will set the corresponding bit in the Questionable Calibration Extended Failure Event register when the condition register bit has a negative transition (1 to 0). The variable <integer> is the sum of the decimal values of the bits that you want to enable.

Mode	All
Remote Command	:STATus:QUESTionable:CALibration:EXTended:FAILure:NTRan sition <integer> :STATus:QUESTionable:CALibration:EXTended:FAILure:NTRan sition?
Example	STAT:QUES:CAL:EXT:FAIL:NTR 1 EMI conducted align failure is not required.
Preset	0
Min	0
Max	32767
Status Bits/OPC dependencies	Sequential command
Initial S/W Revision	Prior to A.02.00
Help Map ID	0

Questionable Calibration Extended Failure Positive Transition

This command determines which bits in the Questionable Calibration Extended Failure Condition register will set the corresponding bit in the Questionable Calibration Extended Failure Event register when the condition register bit has a positive transition (0 to 1). The variable <integer> is the sum of the decimal values of the bits that you want to enable.

Mode	All
Remote Command	:STATus:QUESTionable:CALibration:EXTended:FAILure:PTRan sition <integer> :STATus:QUESTionable:CALibration:EXTended:FAILure:PTRan sition?
Example	STAT:QUES:CAL:EXT:FAIL:PTR 1 EMI conducted align failure is required.
Preset	32767
Min	0

Max	32767
Status Bits/OPC dependencies	Sequential command
Initial S/W Revision	Prior to A.02.00
Help Map ID	0

Questionable Calibration Extended Needed Register

Questionable Calibration Extended Needed Condition

This query returns the decimal value of the sum of the bits in the Questionable Calibration Extended Needed Condition register.

NOTE The data in this register is continuously updated and reflects the current conditions.

Mode	All
Remote Command	:STATus:QUESTionable:CALibration:EXTended:NEEDED:CONDition?
Example	STAT:QUES:CAL:EXT:NEED:COND?
Preset	0
Status Bits/OPC dependencies	Sequential command
Initial S/W Revision	Prior to A.02.00
Help Map ID	0

Questionable Calibration Extended Needed Enable

This command determines which bits in the Questionable Calibration Extended Needed Condition Register will set bits in the Questionable Calibration Extended Needed Event register, which also sets bit 14 of the Questionable Calibration Register. The variable <integer> is the sum of the decimal values of the bits you want to enable.

Mode	All
Remote Command	:STATus:QUESTionable:CALibration:EXTended:NEEDED:ENABle <integer> :STATus:QUESTionable:CALibration:EXTended:NEEDED:ENABle ?
Example	STAT:QUES:CAL:EXT:NEED:ENAB 2 Can be used to query if an EMI conducted alignment is needed.
Preset	32767
Min	0

Max	32767
Status Bits/OPC dependencies	Sequential command
Initial S/W Revision	Prior to A.02.00
Help Map ID	0

Questionable Calibration Extended Needed Event Query

This query returns the decimal value of the sum of the bits in the Questionable Calibration Extended Needed Event register.

NOTE The register requires that the associated PTR or NTR filters be set before a condition register bit can set a bit in the event register. The data in this register is latched until it is queried. Once queried, the register is cleared.

Mode	All
Remote Command	:STATus:QUESTionable:CALibration:EXTended:NEEDED[:EVENT]?
Example	STAT:QUES:CAL:EXT:NEED?
Preset	0
Status Bits/OPC dependencies	Sequential command
Initial S/W Revision	Prior to A.02.00
Help Map ID	0

Questionable Calibration Extended Needed Negative Transition

This command determines which bits in the Questionable Calibration Extended Needed Condition register will set the corresponding bit in the Questionable Calibration Extended Needed Event register when the condition register bit has a negative transition (1 to 0). The variable <integer> is the sum of the decimal values of the bits that you want to enable.

Mode	All
Remote Command	:STATus:QUESTionable:CALibration:EXTended:NEEDED:NTRansition <integer> :STATus:QUESTionable:CALibration:EXTended:NEEDED:NTRansition?
Example	STAT:QUES:CAL:EXT:NEED:NTR 2 Align EMI conducted is not required.
Preset	0
Min	0
Max	32767

Status Bits/OPC dependencies	Sequential command
Initial S/W Revision	Prior to A.02.00
Help Map ID	0

Questionable Calibration Extended Needed Positive Transition

This command determines which bits in the Questionable Calibration Extended Needed Condition register will set the corresponding bit in the Questionable Calibration Extended Needed Event register when the condition register bit has a positive transition (0 to 1). The variable <integer> is the sum of the decimal values of the bits that you want to enable.

Mode	All
Remote Command	:STATus:QUESTionable:CALibration:EXTended:NEEDED:PTRansition <integer> :STATus:QUESTionable:CALibration:EXTended:NEEDED:PTRansition?
Example	STAT:QUES:CAL:EXT:NEED:PTR 2 Align EMI conducted is required.
Preset	32767
Min	0
Max	32767
Status Bits/OPC dependencies	Sequential command
Initial S/W Revision	Prior to A.02.00
Help Map ID	0

Questionable Frequency Register

Questionable Frequency Condition

This query returns the decimal value of the sum of the bits in the Questionable Frequency Condition register.

NOTE The data in this register is continuously updated and reflects the current conditions.

Mode	All
Remote Command	:STATus:QUESTionable:FREquency:CONDition?
Example	STAT:QUES:FREQ:COND?
Preset	0
Status Bits/OPC dependencies	Sequential command

Initial S/W Revision	Prior to A.02.00
Help Map ID	0

Questionable Frequency Enable

This command determines which bits in the Questionable Frequency Condition Register will set bits in the Questionable Frequency Event register, which also sets the Frequency Summary bit (bit 5) in the Questionable Register. The variable <integer> is the sum of the decimal values of the bits you want to enable.

Mode	All
Remote Command	:STATus:QUESTionable:FREQuency:ENABle <integer> :STATus:QUESTionable:FREQuency:ENABle?
Example	STAT:QUES:FREQ:ENAB 2 Frequency Reference Unlocked will be reported to the Frequency Summary of the Status Questionable register.
Preset	32767
Min	0
Max	32767
Status Bits/OPC dependencies	Sequential command
Initial S/W Revision	Prior to A.02.00
Help Map ID	0

Questionable Frequency Event Query

This query returns the decimal value of the sum of the bits in the Questionable Frequency Event register.

NOTE The register requires that the associated PTR or NTR filters be set before a condition register bit can set a bit in the event register. The data in this register is latched until it is queried. Once queried, the register is cleared.

Mode	All
Remote Command	:STATus:QUESTionable:FREQuency[:EVENT]?
Example	STAT:QUES:FREQ?
Preset	0
Status Bits/OPC dependencies	Sequential command
Initial S/W Revision	Prior to A.02.00
Help Map ID	0

Questionable Frequency Negative Transition

This command determines which bits in the Questionable Frequency Condition register will set the corresponding bit in the Questionable Frequency Event register when the condition register bit has a negative transition (1 to 0). The variable <integer> is the sum of the decimal values of the bits that you want to enable.

Mode	All
Remote Command	:STATus:QUESTionable:FREQuency:NTRansition <integer> :STATus:QUESTionable:FREQuency:NTRansition?
Example	STAT:QUES:FREQ:NTR 2 Frequency Reference 'regained lock' will be reported to the Frequency Summary of the Status Questionable register.
Preset	0
Min	0
Max	32767
Status Bits/OPC dependencies	Sequential command
Initial S/W Revision	Prior to A.02.00
Help Map ID	0

Questionable Frequency Positive Transition

This command determines which bits in the Questionable Frequency Condition register will set the corresponding bit in the Questionable Frequency Event register when the condition register bit has a positive transition (0 to 1). The variable <integer> is the sum of the decimal values of the bits that you want to enable.

Mode	All
Remote Command	:STATus:QUESTionable:FREQuency:PTRansition <integer> :STATus:QUESTionable:FREQuency:PTRansition?
Example	STAT:QUES:FREQ:PTR 2 Frequency Reference 'became unlocked' will be reported to the Frequency Summary of the Status Questionable register.
Preset	32767
Min	0
Max	32767
Status Bits/OPC dependencies	Sequential command
Initial S/W Revision	Prior to A.02.00
Help Map ID	0

Questionable Integrity Register

Questionable Integrity Condition

This query returns the decimal value of the sum of the bits in the Questionable Integrity Condition register.

NOTE The data in this register is continuously updated and reflects the current conditions.

Mode	All
Remote Command	:STATus:QUESTIONable:INTEgrity:CONDition?
Example	STAT:QUES:INT:COND?
Preset	0
Status Bits/OPC dependencies	Sequential command
Initial S/W Revision	Prior to A.02.00
Help Map ID	0

Questionable Integrity Enable

This command determines which bits in the Questionable Integrity Condition Register will set bits in the Questionable Integrity Event register, which also sets the Integrity Summary bit (bit 9) in the Questionable Register. The variable <integer> is the sum of the decimal values of the bits you want to enable.

Mode	All
Remote Command	:STATus:QUESTIONable:INTEgrity:ENABle <integer> :STATus:QUESTIONable:INTEgrity:ENABle?
Example	STAT:QUES:INT:ENAB 8 Measurement Uncalibrated Summary will be reported to the Integrity Summary of the Status Questionable register.
Preset	32767
Min	0
Max	32767
Status Bits/OPC dependencies	Sequential command
Initial S/W Revision	Prior to A.02.00
Help Map ID	0

Questionable Integrity Event Query

This query returns the decimal value of the sum of the bits in the Questionable Integrity Event register.

NOTE The register requires that the associated PTR or NTR filters be set before a condition register bit can set a bit in the event register. The data in this register is latched until it is queried. Once queried, the register is cleared.

Mode	All
Remote Command	:STATus:QUESTionable:INTEgrity[:EVENT]?
Example	STAT:QUES:INT?
Preset	0
Status Bits/OPC dependencies	Sequential command
Initial S/W Revision	Prior to A.02.00
Help Map ID	0

Questionable Integrity Negative Transition

This command determines which bits in the Questionable Integrity Condition register will set the corresponding bit in the Questionable Integrity Event register when the condition register bit has a negative transition (1 to 0)

The variable <integer> is the sum of the decimal values of the bits that you want to enable.

Mode	All
Remote Command	:STATus:QUESTionable:INTEgrity:NTRansition <integer> :STATus:QUESTionable:INTEgrity:NTRansition?
Example	STAT:QUES:INT:NTR 8 Measurement 'regained calibration' Summary will be reported to the Integrity Summary of the Status Questionable register.
Preset	0
Min	0
Max	32767
Status Bits/OPC dependencies	Sequential command
Initial S/W Revision	Prior to A.02.00
Help Map ID	0

Questionable Integrity Positive Transition

This command determines which bits in the Questionable Integrity Condition register will set the corresponding bit in the Questionable Integrity Event register when the condition register bit has a positive transition (0 to 1). The variable <integer> is the sum of the decimal values of the bits that you want to enable.

Mode	All
------	-----

Remote Command	:STATus:QUESTionable:INTEgrity:PTRansition <integer> :STATus:QUESTionable:INTEgrity:PTRansition?
Example	STAT:QUES:INT:PTR 8 Measurement 'became uncalibrated' Summary will be reported to the Integrity Summary of the Status Questionable register.
Preset	32767
Min	0
Max	32767
Status Bits/OPC dependencies	Sequential command
Initial S/W Revision	Prior to A.02.00
Help Map ID	0

Questionable Integrity Signal Register

Questionable Integrity Signal Condition

This query returns the decimal value of the sum of the bits in the Questionable Integrity Signal Condition register.

NOTE The data in this register is continuously updated and reflects the current conditions.

Mode	All
Remote Command	:STATus:QUESTionable:INTEgrity:SIGNal:CONDition?
Example	STAT:QUES:INT:SIGN:COND?
Preset	0
Status Bits/OPC dependencies	Sequential command
Initial S/W Revision	Prior to A.02.00
Help Map ID	0

Questionable Integrity Signal Enable

This command determines which bits in the Questionable Integrity Signal Condition Register will set bits in the Questionable Integrity Signal Event register, which also sets the Integrity Summary bit (bit 9) in the Questionable Register. The variable <integer> is the sum of the decimal values of the bits you want to enable.

Mode	All
Remote Command	:STATus:QUESTionable:INTEgrity:SIGNal:ENABLE <integer> :STATus:QUESTionable:INTEgrity:SIGNal:ENABLE?

STATus Subsystem
STATus Subsystem Command Descriptions

Example	STAT:QUES:INT:SIGN:ENAB 4 Burst Not Found will be reported to the Integrity Summary of the Status Questionable register.
Preset	32767
Min	0
Max	32767
Status Bits/OPC dependencies	Sequential command
Initial S/W Revision	Prior to A.02.00
Help Map ID	0

Questionable Integrity Signal Event Query

This query returns the decimal value of the sum of the bits in the Questionable Integrity Signal Event register.

NOTE The register requires that the associated PTR or NTR filters be set before a condition register bit can set a bit in the event register. The data in this register is latched until it is queried. Once queried, the register is cleared.

Mode	All
Remote Command	:STATus:QUESTionable:INTEgrity:SIGNal[:EVENT]?
Example	STAT:QUES:INT:SIGN?
Preset	0
Status Bits/OPC dependencies	Sequential command
Initial S/W Revision	Prior to A.02.00
Help Map ID	0

Questionable Integrity Signal Negative Transition

This command determines which bits in the Questionable Integrity Signal Condition register will set the corresponding bit in the Questionable Integrity Signal Event register when the condition register bit has a negative transition (1 to 0). The variable <integer> is the sum of the decimal values of the bits that you want to enable.

Mode	All
Remote Command	:STATus:QUESTionable:INTEgrity:SIGNal:NTRansition <integer> :STATus:QUESTionable:INTEgrity:SIGNal:NTRansition?
Example	STAT:QUES:INT:SIGN:NTR 4 Burst found will be reported to the Integrity Summary of the Status Questionable register.

Preset	0
Min	0
Max	32767
Status Bits/OPC dependencies	Sequential command
Initial S/W Revision	Prior to A.02.00
Help Map ID	0

Questionable Integrity Signal Positive Transition

This command determines which bits in the Questionable Integrity Signal Condition register will set the corresponding bit in the Questionable Integrity Signal Event register when the condition register bit has a positive transition (0 to 1). The variable <integer> is the sum of the decimal values of the bits that you want to enable.

Mode	All
Remote Command	:STATus:QUESTionable:INTEgrity:SIGNal:PTRansition <integer> :STATus:QUESTionable:INTEgrity:SIGNal:PTRansition?
Example	STAT:QUES:INT:SIGN:PTR 4 Burst not found will be reported to the Integrity Summary of the Status Questionable register.
Preset	32767
Min	0
Max	32767
Status Bits/OPC dependencies	Sequential command
Initial S/W Revision	Prior to A.02.00
Help Map ID	0

Questionable Integrity Uncalibrated Register

Questionable Integrity Uncalibrated Condition

This query returns the decimal value of the sum of the bits in the Questionable Integrity Uncalibrated Condition register.

NOTE The data in this register is continuously updated and reflects the current conditions.

Mode	All
Remote Command	:STATus:QUESTionable:INTEgrity:UNCalibrated:CONDition?

STATus Subsystem
STATus Subsystem Command Descriptions

Example	STAT:QUES:INT:UNC:COND?
Preset	0
Status Bits/OPC dependencies	Sequential command
Initial S/W Revision	Prior to A.02.00
Help Map ID	0

Questionable Integrity Uncalibrated Enable

This command determines which bits in the Questionable Integrity Uncalibrated Condition Register will set bits in the Questionable Integrity Uncalibrated Event register, which also sets the Data Uncalibrated Summary bit (bit 3) in the Questionable Integrity Register. The variable <integer> is the sum of the decimal values of the bits you want to enable.

Mode	All
Remote Command	:STATus:QUESTionable:INTEgrity:UNCalibrated:ENABLE :STATus:QUESTionable:INTEgrity:UNCalibrated:ENABLE?
Example	STAT:QUES:INT:UNC:ENAB 1 Oversweep (Meas Uncal) will be reported to the Integrity Summary of the Status Questionable register.
Preset	32767
Min	0
Max	32767
Status Bits/OPC dependencies	Sequential command
Initial S/W Revision	Prior to A.02.00
Help Map ID	0

Questionable Integrity Uncalibrated Event Query

This query returns the decimal value of the sum of the bits in the Questionable Integrity Uncalibrated Event register.

NOTE The register requires that the associated PTR or NTR filters be set before a condition register bit can set a bit in the event register. The data in this register is latched until it is queried. Once queried, the register is cleared.

Mode	All
Remote Command	:STATus:QUESTionable:INTEgrity:UNCalibrated[:EVENT]?
Example	STAT:QUES:INT:UNC?
Preset	0

Status Bits/OPC dependencies	Sequential command
Initial S/W Revision	Prior to A.02.00
Help Map ID	0

Questionable Integrity Uncalibrated Negative Transition

This command determines which bits in the Questionable Integrity Uncalibrated Condition register will set the corresponding bit in the Questionable Integrity Uncalibrated Event register when the condition register bit has a negative transition (1 to 0). The variable <integer> is the sum of the decimal values of the bits that you want to enable.

Mode	All
Remote Command	:STATus:QUESTionable:INTEgrity:UNCalibrated:NTRansition <integer> :STATus:QUESTionable:INTEgrity:UNCalibrated:NTRansition ?
Example	STAT:QUES:INT:UNC:NTR 1 Oversweep cleared will be reported to the Integrity Summary of the Status Questionable register.
Preset	0
Min	0
Max	32767
Status Bits/OPC dependencies	Sequential command
Initial S/W Revision	Prior to A.02.00
Help Map ID	0

Questionable Integrity Uncalibrated Positive Transition

This command determines which bits in the Questionable Integrity Uncalibrated Condition register will set the corresponding bit in the Questionable Integrity Uncalibrated Event register when the condition register bit has a positive transition (0 to 1). The variable <integer> is the sum of the decimal values of the bits that you want to enable.

Mode	All
Remote Command	:STATus:QUESTionable:INTEgrity:UNCalibrated:PTRansition <integer> :STATus:QUESTionable:INTEgrity:UNCalibrated:PTRansition ?
Example	STAT:QUES:INT:UNC:PTR 1 Oversweep (Meas Uncal) occurred will be reported to the Integrity Summary of the Status Questionable register.
Preset	32767
Min	0

STATus Subsystem
STATus Subsystem Command Descriptions

Max	32767
Status Bits/OPC dependencies	Sequential command
Initial S/W Revision	Prior to A.02.00
Help Map ID	0

Questionable Power Register

Questionable Power Condition

This query returns the decimal value of the sum of the bits in the Questionable Power Condition register.

NOTE The data in this register is continuously updated and reflects the current conditions.

Mode	All
Remote Command	:STATus:QUESTionable:POWer:CONDition?
Example	STAT:QUES:POW:COND?
Preset	0
Status Bits/OPC dependencies	Sequential command
Initial S/W Revision	Prior to A.02.00
Help Map ID	0

Questionable Power Enable

This command determines which bits in the Questionable Power Condition Register will set bits in the Questionable Power Event register, which also sets the Power Summary bit (bit 3) in the Questionable Register. The variable <integer> is the sum of the decimal values of the bits you want to enable.

Mode	All
Remote Command	:STATus:QUESTionable:POWer:ENABle <integer> :STATus:QUESTionable:POWer:ENABle?
Example	STAT:QUES:POW:ENAB 32 50 MHz Input Pwr too High for Cal will be reported to the Power Summary of the Status Questionable register.
Preset	32767
Min	0
Max	32767
Status Bits/OPC dependencies	Sequential command
Initial S/W Revision	Prior to A.02.00

Help Map ID	0
-------------	---

Questionable Power Event Query

This query returns the decimal value of the sum of the bits in the Questionable Power Event register.

NOTE The register requires that the associated PTR or NTR filters be set before a condition register bit can set a bit in the event register. The data in this register is latched until it is queried. Once queried, the register is cleared.

Mode	All
Remote Command	:STATus:QUESTionable:POWer[:EVENT]?
Example	STAT:QUES:POW?
Preset	0
Status Bits/OPC dependencies	Sequential command
Initial S/W Revision	Prior to A.02.00
Help Map ID	0

Questionable Power Negative Transition

This command determines which bits in the Questionable Power Condition register will set the corresponding bit in the Questionable Power Event register when the condition register bit has a negative transition (1 to 0). The variable <integer> is the sum of the decimal values of the bits that you want to enable.

Mode	All
Remote Command	:STATus:QUESTionable:POWer:NTRansition <integer> :STATus:QUESTionable:POWer:NTRansition?
Example	STAT:QUES:POW:NTR 32 50 MHz Input Power became OK for Cal will be reported to the Power Summary of the Status Questionable register.
Preset	0
Min	0
Max	32767
Status Bits/OPC dependencies	Sequential command
Initial S/W Revision	Prior to A.02.00
Help Map ID	0

Questionable Power Positive Transition

This command determines which bits in the Questionable Power Condition register will set the

STATus Subsystem
STATus Subsystem Command Descriptions

corresponding bit in the Questionable Power Event register when the condition register bit has a positive transition (0 to 1). The variable <integer> is the sum of the decimal values of the bits that you want to enable.

Mode	All
Remote Command	:STATus:QUESTionable:POWer:PTRansition <integer> :STATus:QUESTionable:POWer:PTRansition?>
Example	STAT:QUES:POW:PTR 32 50 MHz Input Power became too high for Cal will be reported to the Power Summary of the Status Questionable register.
Preset	32767
Min	0
Max	32767
Status Bits/OPC dependencies	Sequential command
Initial S/W Revision	Prior to A.02.00
Help Map ID	0

Questionable Temperature Register

Questionable Temperature Condition

This query returns the decimal value of the sum of the bits in the Questionable Temperature Condition register.

NOTE The data in this register is continuously updated and reflects the current conditions.

Mode	All
Remote Command	:STATus:QUESTionable:TEMPerature:CONDition?
Example	STAT:QUES:TEMP:COND?
Preset	0
Status Bits/OPC dependencies	Sequential command
Initial S/W Revision	Prior to A.02.00
Help Map ID	0

Questionable Temperature Enable

This command determines which bits in the Questionable Temperature Condition Register will set bits in the Questionable Temperature Event register, which also sets the Temperature Summary bit (bit 4) in the Questionable Register. The variable <integer> is the sum of the decimal values of the bits you want to

enable.

Mode	All
Remote Command	:STATus:QUESTionable:TEMPerature:ENABle <integer> :STATus:QUESTionable:TEMPerature:ENABle?
Example	STAT:QUES:TEMP:ENAB 1 Reference Oscillator Oven Cold will be reported to the Temperature Summary of the Status Questionable register.
Preset	32767
Min	0
Max	32767
Status Bits/OPC dependencies	Sequential command
Initial S/W Revision	Prior to A.02.00
Help Map ID	0

Questionable Temperature Event Query

This query returns the decimal value of the sum of the bits in the Questionable Temperature Event register.

NOTE The register requires that the associated PTR or NTR filters be set before a condition register bit can set a bit in the event register. The data in this register is latched until it is queried. Once queried, the register is cleared

Mode	All
Remote Command	:STATus:QUESTionable:TEMPerature[:EVENT]?
Example	STAT:QUES:TEMP?
Preset	0
Status Bits/OPC dependencies	Sequential command
Initial S/W Revision	Prior to A.02.00
Help Map ID	0

Questionable Temperature Negative Transition

This command determines which bits in the Questionable Temperature Condition register will set the corresponding bit in the Questionable Temperature Event register when the condition register bit has a negative transition (1 to 0). The variable <integer> is the sum of the decimal values of the bits that you want to enable.

Mode	All
------	-----

STATus Subsystem
STATus Subsystem Command Descriptions

Remote Command	:STATus:QUESTionable:TEMPerature:NTRansition <integer> :STATus:QUESTionable:TEMPerature:NTRansition?
Example	STAT:QUES:TEMP:NTR 1 Reference Oscillator Oven not cold will be reported to the Temperature Summary of the Status Questionable register.
Preset	0
Min	0
Max	32767
Status Bits/OPC dependencies	Sequential command
Initial S/W Revision	Prior to A.02.00
Help Map ID	0

Questionable Temperature Positive Transition

This command determines which bits in the Questionable Temperature Condition register will set the corresponding bit in the Questionable Temperature Event register when the condition register bit has a positive transition (0 to 1). The variable <integer> is the sum of the decimal values of the bits that you want to enable.

Mode	All
Remote Command	:STATus:QUESTionable:TEMPerature:PTRansition <integer> :STATus:QUESTionable:TEMPerature:PTRansition?
Example	STAT:QUES:TEMP:PTR 1 Reference Oscillator Oven became cold will be reported to the Temperature Summary of the Status Questionable register.
Preset	32767
Min	0
Max	32767
Status Bits/OPC dependencies	Sequential command
Initial S/W Revision	Prior to A.02.00
Help Map ID	0